

使用說明書 INSTRUCTION MANUAL

HITACHI

日立多門雪櫃

REFRIGERATOR-FREEZER

家庭用 For household use

型號
Model R-HV490RH R-HV490RS



日本製
Made in Japan

六門 6 doors

非常感謝您購買日立雪櫃。

此雪櫃僅供家庭使用，請勿用於商業行為或儲存食品以外的其他目的。

請詳閱本使用說明書，以確保正確使用。

請妥善保管本使用說明書與保證書。如將雪櫃交給他人在別的場所使用或者交給回收工廠，請將本使用說明書隨雪櫃一同轉交。

Thank you for purchasing a Hitachi refrigerator. This refrigerator is designed for home use only. Do not use this refrigerator for commercial use or for any purpose other than storing food. Please keep this manual, together with your warranty, in a safe place. If you hand this refrigerator over to another party, pass on this manual as well.

使用前請詳閱「安全上的注意事項」，以確保正確使用。

→4~7頁

Please read "Safety Suggestions" in this manual to ensure correct usage and safety before use.

→Pg.40-43

節省電力的使用方法

Tips for using the refrigerator wisely for energy savings

1. 減少開關雪櫃門的次數，若打開後也請盡快關上

頻繁地開關雪櫃門會讓冷空氣向外流失。

2. 避免過分堆滿食品

食品堆積過滿時，雪櫃內部冷氣循環變差，難以達到充分冷卻，容易造成耗電及浪費。建議儲存食物時以看到雪櫃內部最後面為主及保留間隙。

3. 溫熱的東西請常溫放涼後再冷藏

將熱食放進雪櫃會讓溫度上升，造成附近的食品容易變質。

4. 雪櫃周邊應保留適當的間隙

若周圍沒有足夠的空間，會無法散熱造成耗電。

5. 更換老化的雪櫃門密封墊

密封墊老化後會容易讓內部的冷空氣向外流失，造成耗電。若出現這種狀況，可先拿一張名片夾在門縫處，若關上雪櫃門後名片掉落，建議盡快更換新的密封墊。

1. Reduce the rate of opening and closing of doors.

Frequent opening and closing leads to waste of energy.

2. Do not overfill the refrigerator.

Overfilling the refrigerator prevents smooth circulation of cool air, even cooling throughout and consumes unnecessary power. Place food that you can see the back wall of the refrigerator.

3. Do not place hot food in the refrigerator.

Placing hot food in the refrigerator raises the temperature, which, in turn, raises the temperature of surrounding food.

4. Provide sufficient spacing around the refrigerator.

Installing the refrigerator with insufficient clearance between the refrigerator and surrounding objects prevents the release of heat and thus leads to waste of energy.

5. Replace door gaskets if damaged.

Cool air can leak through damaged gaskets, which leads to waste of energy. If a business card inserted between the gasket and the refrigerator slides down, the gasket needs replacing.

常見問題

FREQUENTLY-ASKED QUESTIONS (FAQs)

無法製冰時

→ 31 頁

If you cannot make ice

→ Pg.67

雪櫃內部不冷時

→ 30 頁

If the refrigerator is not cool

→ Pg.66

結霜或結露時

→ 30 頁

If frost or condensation is formed

→ Pg.66

目錄

使用之前

安全上的注意事項	4
事前準備	8
使用前的準備	8
確認事項	10
操作面板的功能/各室的名稱	10
顯示部分	10
適合存放的食品	11

使用方式

冷藏室	12
各部的名稱	12
調校溫度(冷藏室)	12
「Moisture Cooling」的使用	12
快速冷藏功能 (「Quick Cooling」的使用)	13
雪櫃門的開關	13
置物架、層架高度的調整	13
-1°C特鮮冰溫室	14
食品收納	14
-1°C特鮮冰溫室的開關	15
製冰室(自動製冰機)	16
製冰方法	16
冰的收納量、製冰時間	17
短時間內製冰	17
不製冰	17
給水警示燈	17
Ice Maker 「On」或 Freezer 「Coldest / Cold」及 Fridge 「Cold」燈號閃爍時	17
冰凍室	18
收納食品/收納食品時	18
肉類、魚類及白飯快速冰凍時 (「Delicious Freezing」的使用)	19
調校溫度(冰凍室)	19
蔬果保鮮室	20
收納食品/收納食品時	20
調校蔬果保鮮室的溫度(使用「蔬果室強」)	21
蔬果保存時的訣竅	21
各種功能	22
溫度微調節(冷藏室、冰凍室)	22
eco 運轉顯示燈	22
雪櫃門警報器	23
雪櫃門警報器及操作聲音的音量調節	23
三重除臭過濾(冷藏室)	23
省電	24
省電模式	24

保養方法

保養方法	25
電源插頭/雪櫃門密封墊	25
雪櫃門表面/各層架、置物架/液體承接處	25
雪櫃背面、側面、地板/置物格	25
-1°C特鮮冰溫室	26
儲水箱	26
製冰機清潔	27
卸除組件的方法、安裝的方法	28
可調式層架上段、中段	28
可調式層架下段	28
固定層架	28
棚架	28
雪櫃門置物架	28
-1°C特鮮冰溫室	28
製冰格(製冰室)、上層冰凍格(上層冰凍室)	29
中層滑動格、下層冰凍格(下層冰凍室)	29
上層滑動格、下層置物格(蔬果保鮮室)	29
拉取式門的安裝方法	29

遇到問題時/關於售後服務

遇到問題時	30
初次使用時	30
不冷	30
結霜或結露	30
自動製冰	31
操作面板燈號閃爍	32
蔬果保鮮室的問題	32
-1°C特鮮冰溫室的問題	33
雪櫃門高低不平衡以及歪斜	33
有異味	33
太冷	33
雪櫃變熱	33
聲音不對	34
其他	35
移動、搬運的事前準備(搬家時)	36
另購零件	36
有關碳氫化合物的雪櫃/ 可容納的食品重量	75
關於售後服務	76

安全上的注意事項

請務必遵守

為了防止危害到使用者或其他人及造成財務上的損失，請務必遵守以下事項。

■ 以下將以標示方式，區分及說明忽視標示內容而誤用時所產生的危害與損失程度。

■ 以下將以圖示標示方式，區分及說明應遵守內容的種類。(以下為圖示標示例)

 **警告** 此標示欄表示「可能會造成死亡或嚴重人身傷害」。

 **注意** 此標示欄表示「可能會發生人身傷害或財產損失之預測內容」。

 「提醒警告及注意」的內容。

 此圖示標示為「禁止」內容(請勿執行之事項)。

 此圖示標示為「強制」內容(請務必執行之事項)。

■ 此雪櫃使用可燃性的雪種。以下的標示欄記載關於可燃性雪種的注意事項。



此圖示標示為可燃性雪種的注意事項。

警告

安裝時



- 針對地震等天然災害做好防止翻倒處置。
 - 避免因翻倒而受傷。

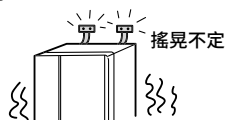

禁止淋濕

- 請勿設置於潮濕或會被水淋到的場所。
 - 避免因電氣接觸不良而引起觸電·火災的危險。

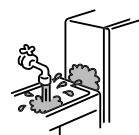

- 請勿在本產品的背面設置電拖板。

電源及電線



禁止

- 使用時請勿高於插座或配線器具的額定電流。請勿使用交流額定電壓以外的電源。若與其他電器插頭併用，或使用三面插座等，會因異常發熱而造成火災的危險。
 - 請單獨使用額定電流 10A 以上的插座。

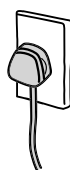

- 設置本產品時，請確認電線是否有拉扯、損傷的跡象。

(請勿讓電線受損·加工·接近發熱器具·曲·拉扯·乘載重物·讓雪櫃壓住電線或捆綁電線。)

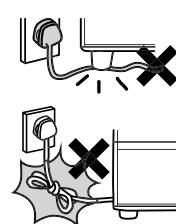

- 在已受損的狀態下使用時，會引發觸電·短路·火災的危險。
- 若電線損壞時，必須由製造商、其服務處或具有相關資格的人員加以更換以避免危險。



- 將插頭的電線向下，將插頭確實插入插座內。
 - 如果插頭方向相反插入，會給電線增加負擔，成為短路·觸電·起火的原因。
 - 如果插頭插得不夠完全，也將會成為因觸電，發熱而導致火災的原因。

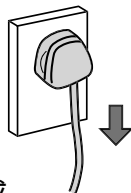

- 請定期清除插頭上的灰塵。當插頭堆積灰塵時會因濕氣而造成接觸不良，進而引起火災。
 - 請拔除插頭再用乾布擦拭乾淨。



警告

電源及電線



禁止濕手

- 請勿用潮濕的手，拔除插頭。
 - 會引起觸電。

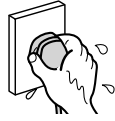

- 進行雪櫃保養時，請務必拔掉插頭。
 - 有觸電或受傷的危險。

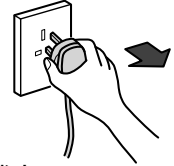

→ 25頁

- 請將插頭確實的從插座內拔出。

在一般使用的情況下



禁止淋濕

- 請勿用水淋濕主體與箱內。
 - 避免因電氣接觸不足而引起觸電· 火災。

- 請勿將含水容器放在雪櫃上。
 - 翻倒的水會造成電氣組件接觸不良而發生漏電· 火災· 觸電的危險。



禁止

- 請勿放入容易引火的物品。
 - 揮發油· 乙醚· LP 瓦斯· 稀釋液· 黏著劑會發生引爆的危險。

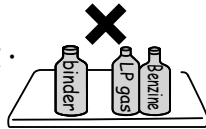

- 請勿用來保存藥品或學術試樣。
 - 必須嚴格管理的物品，不可保存於家庭用雪櫃內。



- 請勿放置乾冰。
 - 放入袋中有破裂的危險。

- 在附近請勿使用可燃性噴霧用品。
 - 避免因雪櫃門開關等電氣接點引起的火花引發火災。

- 請勿在雪櫃上放置物品。
 - 避免因開關雪櫃門時，造成物品掉落而受傷。

- 請勿懸在雪櫃門上嬉戲，或踏在收納盒上。
 - 避免因翻倒，夾到手指而受傷。

- 請不要拆卸雪櫃內燈的蓋子。
 - 燈泡損壞時，須由製造廠商或其服務處或具有相關資格的人員加以更換以避免危險。

- 不要將雪櫃門開得過大或大力靠在打開的雪櫃門上等給雪櫃門施加過大的壓力。

- 不要用力碰撞門。



禁止接觸

- 請勿用手觸碰自動製冰機的零件部位。
 - 製冰盤旋轉時，手恐怕會受傷。

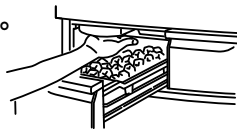

- 在使用本雪櫃時，除非由負責安全的人監督或指導，不適合讓身體、感官或精神能力下降或缺乏經驗及知識的人（包含兒童）使用。請注意不要讓孩子們用雪櫃作玩耍用途。

安全上的注意事項～續前頁～



關於雪種（由於這是一種可燃性的氣體 R600a: 異丁烷，請注意以下的事項。）



禁止

- 不可以螺絲等銳利物品刮花雪櫃。
由於使用可燃性的雪種，當雪種從雪櫃內壁的配管外洩，會有起火・爆炸的危險。

- 除廠商建議方法外，不得使用零件工具或其它工具來加速除霜的過程。

- 請勿在雪櫃內部使用電器用品。
・如雪種外洩，電氣接點所產生的火花，會有起火・爆炸的危險。



- 請勿損壞雪櫃的雪種管路。
雪種配管損壞時，請將雪櫃遠離火源並避免使用電器用品。
配管損壞時，請儘快將門窗打開，並與經銷商或日立服務中心聯絡。

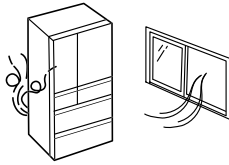

- 請將本產品的外殼或組裝結構上的通氣口遠離障礙物。 → 8頁
若雪種外洩的情況持續，會有起火・爆炸的危險。

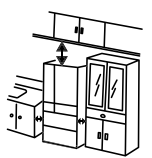

- 如需進行廢棄處理時，請聯絡經銷商或環保署資源回收中心專線，交給他們進行專業處理。
若雪種外洩會有起火・爆炸的危險。



R600a

- 警告標籤和名牌必須一直牢固張貼於壓縮機上和雪櫃上。

- 關於使用後的可燃性雪種的處理、修理、廢棄、設置等，只有日立公司認定的服務公司或維修人員才能進行。

萬一有以下情況



- 當產品異常或故障時，請拔掉插頭停止運轉。
有觸電或受傷的危險。
・請務必在拔除插頭時握住插頭。

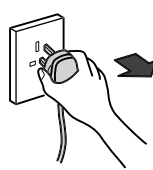

禁止分解

- 請勿自行分解，修理及改造。
避免發生火災，異常動作而受傷。
・需分解或維修時，請洽經銷代理商。



- 可燃性氣體外漏時，勿接觸雪櫃，請立即開啟窗戶進行換氣。
・避免因雪櫃門開關等電氣接點的火花，而發生引爆・火災或燙傷等危險。



廢棄處理時



- 在等待廢物棄置及回收之時，請將門墊拆下來，避免有幼兒被誤困在雪櫃內。

注意

移動或搬運時



禁止

- 請勿在容易刮花的地板上使用雪櫃滑輪。避免因滑輪而刮花地板。
 - 請在容易刮花的地板上鋪上保護板。
- 請勿以吊車吊起把手部位。
- 請勿碰撞雪櫃背面・側面。

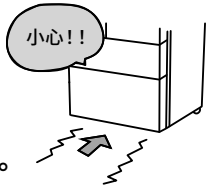

- 搬運時，請用把手搬運。倘若沒有把手，可能會因手滑而受傷。
 - 請僱用 2 人以上把手搬運。
 - 搬運時請如圖示般將雪櫃門朝上。
 - 為了防止電源插頭、電線下垂，請以膠布固定。

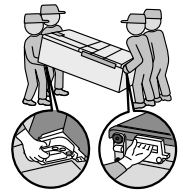

在一般使用的情況下



禁止

- 請勿在超大瓶飲料的縫隙間再塞入其他瓶罐。
 - 勉強放入超大瓶飲料瓶後，在開關雪櫃門時，可能會因掉落而受傷。
- 請勿將瓶子放在冰凍室內。
 - 當瓶子內的物料結凍時，會使瓶子破裂，造成受傷。



- 當打開雪櫃門時，若其他門也在進行開關動作時，請注意不要被打開的雪櫃門之間夾傷手或手指。

- 關閉雪櫃門時，請勿握住雪櫃門把手以外的部位進行關閉。

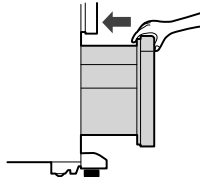

- 開啟最底層的雪櫃門時，請勿讓腳靠近雪櫃。
 - 碰觸到腳底而受傷。



- 手腳不要放進雪櫃的底部。清理時將手伸入雪櫃底下時，可能會被鐵板割傷。

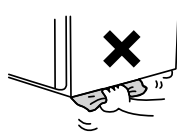

- 請勿施加強烈撞擊力於玻璃層架。(可能因玻璃層架破裂而導致受傷)

- 請勿讓食品凸出層架。
 - 避免因鈎到瓶罐後掉落而受傷。

- 開閉雪櫃門時，請勿過於用力。(存放的食品有可能會掉落)

- 他人同時觸摸時請勿進行開關動作。

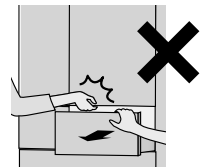

- 請勿將手放在抽屜門把手上，開關冷藏室門。

- 請勿用潮濕的手碰觸冰凍室內的食品或容器。
 - 避免凍傷。(尤其是金屬製產品)

- 請勿食用有異味，已變色的食品。
 - 避免因食品腐敗而引發疾病。

- 請勿在玻璃層架的玻璃面上加熱，或放置熱的物品。



- 為了防止水滴到地板上。長時間門與雪櫃間有縫隙時，結露水或除霜水可能會滴下。請確實關緊雪櫃門讓門與雪櫃之間沒有縫隙。
- 雪櫃門開啟的狀態下，開啟其他的門時，請注意切勿被開啟的雪櫃門夾傷手或手指。

- 因為玻璃層架很重，安裝、拆卸時請格外注意。

- 開關雪櫃門時，若有異常聲音或磨耗粉末掉落等異常現象時，請停止使用，並請維修人員上門檢查。

事前準備

使用前的準備

1

請安裝在以下的位置。

- 地板堅固且水平的地方
地毯、榻榻米、木板地、塑膠地板等恐怕會有變形、變色的可能時，請墊(超過1cm厚的)板材。
- 避免陽光直射及高溫的地方
這些可防止冷卻功率下降，避免電費增加。
- 不潮濕且空氣流通的地方
而且可抑制生鏽及結露。
- 與電視等電器間隔一段距離
防止造成雜音或影像不穩定等情況。

- ※ 雪櫃側面的中央部分可能比所表示的尺寸稍大。
設置時請確保充裕的空間。
- ※ 若擔心振動音或濕氣較高時背面牆壁或壁紙發生變色污損的情況，請將雪櫃與牆壁間請預留間隙(2cm以上)。

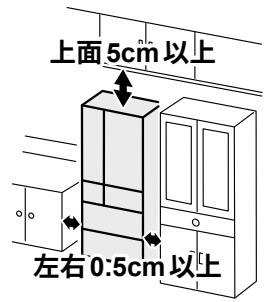

2

調整雪櫃水平後固定。

1 手持腳座護蓋，拉向身前即可卸下。

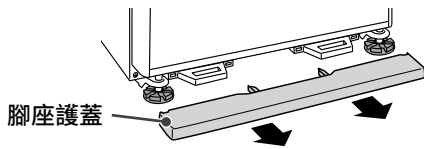

2 將調整墊放在調節腳的下方。

將調節腳調整至前後左右平衡的狀態。

- 在放入調整墊之前，請將調節腳的底部與地板擦拭乾淨。
若有髒污時將有可能會刮傷地板。

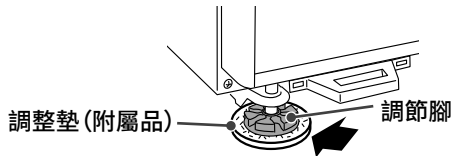

3 旋轉左右的調節腳，直到碰觸到地板。 調整冷藏室的左右側門直到平行為止。

調節腳的旋轉量是以每旋轉1圈相當於雪櫃門的高低差距1mm為準。
如果調節腳難以轉動，請插入十字螺絲刀並轉動。

■ 左側下歪

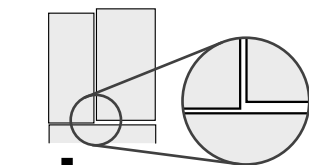

順時針方向旋轉降低左邊的調節腳

■ 右側下歪

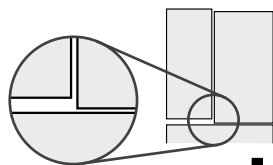

順時針方向旋轉降低右邊的調節腳

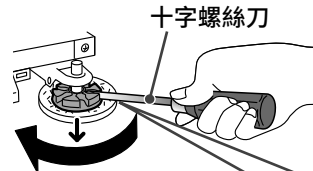
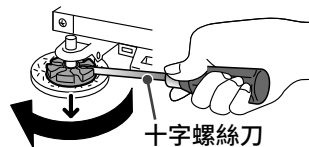

- 轉動調節腳時請小心不要讓十字螺絲刀刮傷地板。
- 當過度旋轉調節腳時，可能導致調節腳脫落。

4 請將腳座護蓋的卡榫插入雪櫃的安裝孔內安裝。

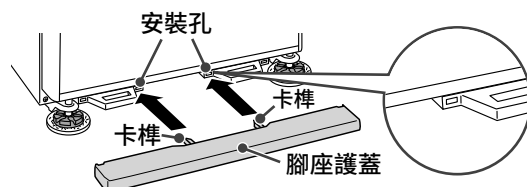

請使用附屬 [2個] 調整墊。



通知事項

- 包裝規格可能因製造時期而異，在品質方面沒有問題。
- 因地板材質的強度、食品的重量，在經過數日後(約5天)或許發生雪櫃門往下降低的情況。若發生此情形，請再次調整平行。
- 可能會因雪櫃放置於非水平的場所，或是地板材質柔軟，而導致雪櫃門左右出現高低差。
雖然功能上沒有問題，但若介意請按上側所列的步驟進行平衡調整。
- 進行左右水平調整，並使雪櫃的前側稍微高一點可方便關門以避免門沒關緊。
- 在雪櫃門開啟的狀態下，手若放開後，雪櫃門可能會慢慢自行關上，此情況非故障。

十字螺絲刀的大小參考

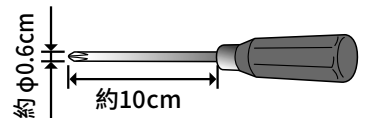

使用十字螺絲刀時，請確實插入調節腳的溝部後旋轉。

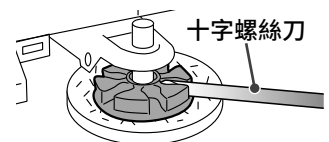

3

清潔雪櫃內部。 → 25~27頁

- 請用沾濕的柔軟布擦拭後，再以乾布擦乾。
- 儲水箱及淨水濾片請使用清水沖洗。
- ※ 滑動盒的滑軌及滑軌接觸面上塗有潤滑劑，請勿擦拭。
- ※ 剛開始使用時可能會有些許塑膠的味道。
若特別在意時，可加強室內通風讓氣味散去。(開始使用後氣味也會自行消失)

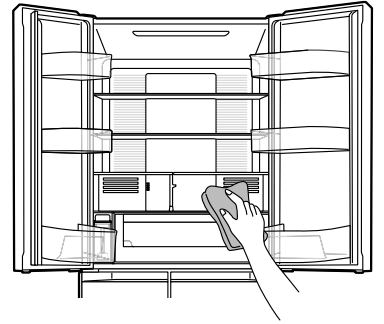

4

將電源插頭插上。

設置後就可直接插上電源插頭。
請用獨立的插座。(交流 220 ~ 240V、額定 10A 以上)

- 請勿將電源插頭及電線夾在雪櫃背面及牆壁間。以防止電線發熱。

雪櫃內開始冷卻 (冷藏室冷卻後，其他的儲藏室(製冰室、冰凍室、蔬果保鮮室)也會接著冷卻)

- 根據雪櫃周圍溫度、食品的存放方式不同，雪櫃內充分冷卻約需要 4 小時。
夏天天氣炎熱時，也可能需要 24 小時以上。
在雪櫃尚未充分冷卻前請勿將雪糕或未充分冷卻的食品、易受損的食品等放入雪櫃。
- 初次使用自動製冰時，請操作自動製冰機的「製冰機清潔」。 → 27 頁
- 自動進行連續的製冰運轉是必須在雪櫃內充分冷卻之後才能開始。
(初次使用時，**最初的結冰可能需要花 24 小時以上。**)
- 當雪櫃內溫度較低時，插上電源後有可能經過 10 分鐘才開始冷卻。

通知事項

- 配管有可能需要進行防鏽處理。
當雪櫃設置在溫泉區、工業區周圍、下水道管路附近等處，有可能受到硫化氣體的影響而導致配管的腐蝕。請向經銷店諮詢。
若因氣體危害導致配管變黑或是故障時，不在保用範圍內。
- 將電源插頭插入後、會有馬達運轉聲音。此外、雪櫃在達到充分冷卻之前、壓縮機及風扇可能會發出較大的聲音。
- 請勿將背面的標籤撕下、或拆卸側面下方的塑膠製品。
- 磁鐵裝飾或是吸盤吸附在雪櫃或雪櫃門表面有可能會留下痕跡。
- 周圍濕度較高時，雪櫃門表面可能結露，而讓貼在雪櫃門上的紙濕掉。

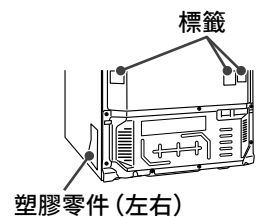

確認事項

操作面板的功能

製冰

- Quick → 17 頁
- On → 16 頁
- Off → 17 頁

冷卻模式

- Moist Cool → 12 頁
- Veg → 21 頁
- Quick Cool → 13 頁

省電

各室冷卻調弱後即為省電

- Save → 24 頁

敬請依照指示操作

請勿對操作面板施加強力的撞擊，或用硬物碰撞。

通知事項

- 操作面板燈號不停閃爍時 → 32 頁

冰凍、冷藏

冰凍室、冷藏室的室內溫度可三段階調整

- 調校溫度 → 12、19 頁

各室的名稱

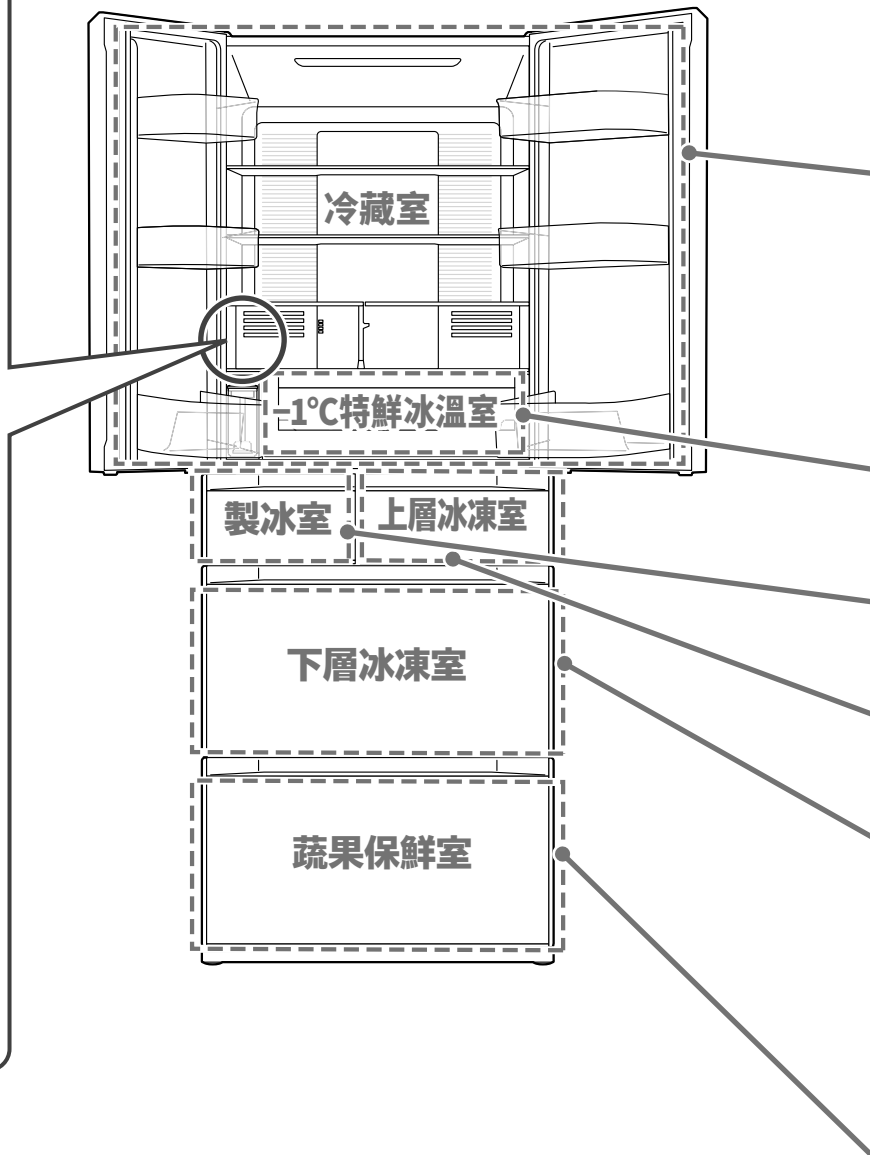

顯示部分

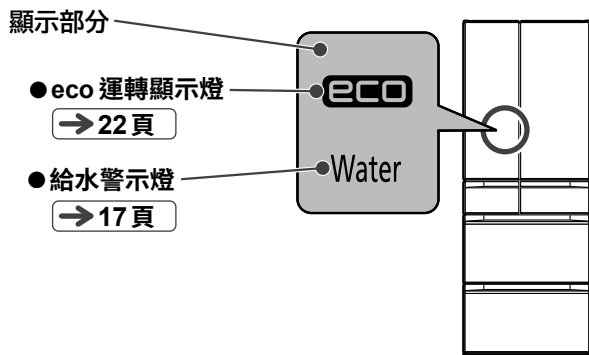

適合存放的食品

存放位置		大概的溫度	食品
冷藏室 → 12 頁	層架	約 2°C ~ 6°C	日常使用的食品 
	雪櫃門置物架	約 2°C ~ 9°C	
-1°C 特鮮冰溫室 → 14 頁		約 -2°C ~ 0°C	魚類肉類等新鮮食品 
製冰室 → 16 頁		約 -19°C ~ -17°C	自動製冰
上層冰凍室 → 18 頁		約 -19°C ~ -17°C	
下層冰凍室 → 18 頁		約 -20°C ~ -18°C	
蔬果保鮮室 → 20 頁	上層、下層 存放空間	約 4°C ~ 8°C	上層存放空間 小型或使用過的蔬果等  下層存放空間 葉菜類 (菠菜、小松菜等)、大型蔬菜 (高麗菜、生菜等) 
	直立收納 空間	約 4°C ~ 9°C	直立收納空間 較大株的蔬菜及寶特瓶等 

※ 是環境溫度在 32°C，冷藏室與冰凍室都設定為「Normal」，不放食品，關著雪櫃門，溫度穩定時的大概溫度。

※ 因食品的存放狀態及櫃門的開關動作，溫度可能會變動。

保存的訣竅

- 收納時請保留食品間的空隙。
- 建議您在存放強烈氣味食品時，先以保鮮膜包覆之後再放入雪櫃。
- 可以收納食品重量的概略基準。 → 75 頁

冷藏室

各部的名稱

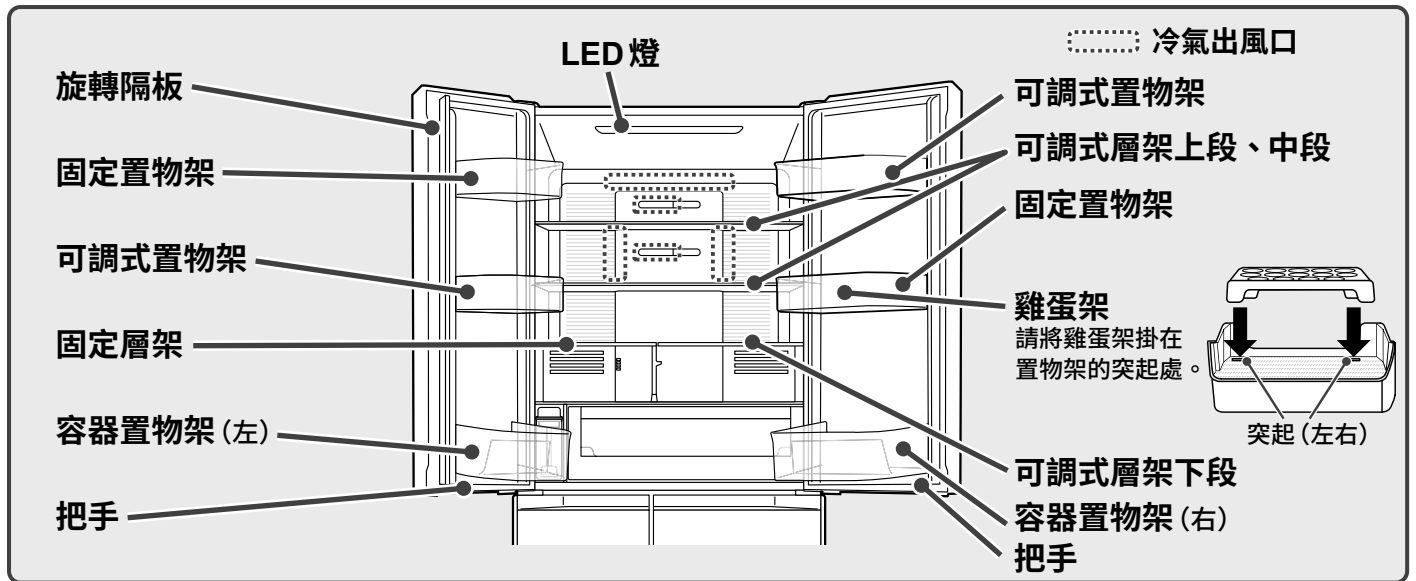
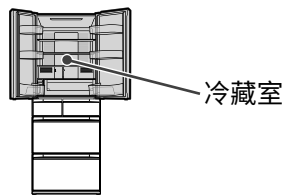

敬請依照指示操作

- 若將水分較多的食品或罐裝飲料放置在冷氣出風口前，有可能結凍或破裂，請勿將該類食品放置在冷氣出風口前。特別是設定成「Coldest」「Moist Cool」時，更容易結凍。將食品加蓋或包裹保鮮膜，可以防止食品結凍。
- 存放米或海苔類等乾燥食品時，使用密閉容器裝盛後再放入雪櫃。乾燥食品會吸收濕氣。

調校溫度 (冷藏室)

按下 **Fridge** 按鍵，可調整溫度。

購買時設定成「Normal」的狀態。

若在夏天感覺冷度不夠時，請設定為「Coldest」。

敬請依照指示操作

若覺得雪櫃內太冷時，請設定為「Normal」或「Cold」就可以。

通知事項

- 雪櫃內部溫度因使用條件不同可依此變動。
- 您亦可以微細調校溫度的設定。 → 22 頁
- 設定為「Moist Cool」時，冷藏室的溫度設定燈號熄滅。

■ 操作面板

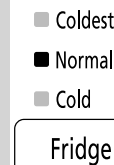

冷藏室的大概溫度

「Coldest」比「Normal」溫度低 1 ~ 3°C

「Cold」比「Normal」溫度高 1 ~ 3°C

「Moisture Cooling」的使用

- 比冷藏室全段還要低溫。(設定時：約 0 ~ 3°C)

建議用於存放常用小菜。

當要保存溫熱食品時，請放冷至能以手碰觸的程度 (50°C 以下) 後再放入。防止燙傷或層架因過熱而變形。

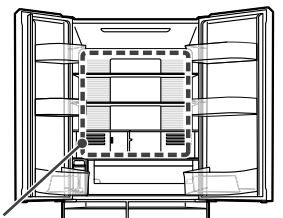

「Moisture Cooling」空間

設定方法

購買時設定成「關」的狀態。

長按 3 秒以上，直到 **Powerful** 的設定音效發出 (嗶—)，讓「Moist Cool」燈號亮起。

讓 **Fridge** 的溫度設定燈號熄滅。

中途解除時

長按 3 秒以上，直到 **Powerful** 的設定音效發出 (嗶嗶)，讓「Moist Cool」燈號熄滅。

■ 操作面板

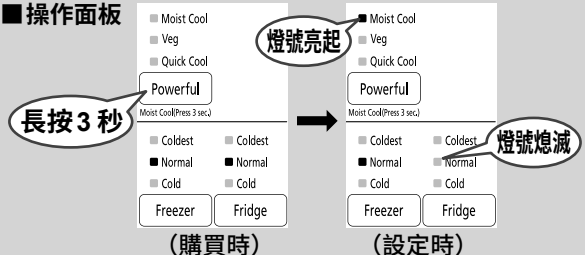

快速冷藏功能 (「Quick Cooling」的使用)

想要快速冷藏食品時，進行「Moisture Cooling」空間的加強冷卻效果的運轉。

可縮短溫熱食品的冷卻或加熱調理後餘熱放涼的時間。

建議可使用在外出前需快速將便當、飲料、加熱調理後的蔬菜冷卻。

當要保存溫熱食品時，請放冷至能以手碰觸的溫度 (50°C以下) 後再放入。

防止燙傷或層架因過熱而變形。

通知事項

- 設定為「Quick Cool」時會比不設定時更耗電。
- 若連續使用「Quick Cool」時，雪櫃內的食品可能會結凍。
- 原本設定在「Moist Cool」時也可同時使用。

設定方式

購買時設定成「關」的狀態。

按下 **Powerful** 按鍵，「Quick Cool」燈號亮起。

運轉約 60 分鐘後自動結束，「Quick Cool」燈號熄滅。

依冷藏室的溫度不同，也可能會運轉超過 60 分鐘。

中途解除時

按下 **Powerful** 按鍵，「Quick Cool」燈號熄滅。

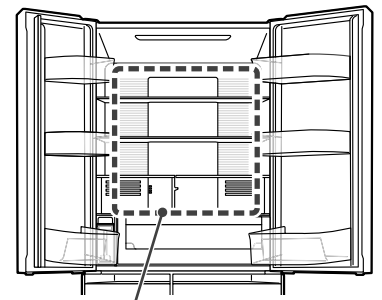

「Moisture Cooling」空間

操作面板

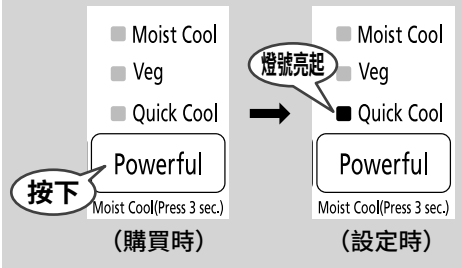

冷藏室

雪櫃門的開關

敬請依照指示操作 打開雪櫃門時，請勿用力過猛，全身靠在打開的雪櫃門上，或是強加不當的外力。有可能造成雪櫃門的損壞。

開關雪櫃時，請使用把手開關雪櫃門。

■ 開啟雪櫃門時

請勿只握住旋轉隔板打開雪櫃門。
(可能造成雪櫃門無法開啟)

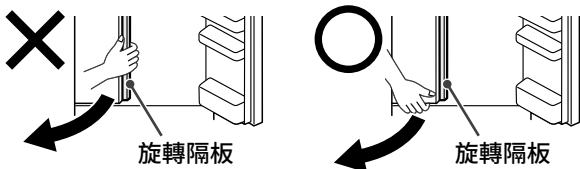

■ 關上雪櫃門時

當旋轉隔板為立起狀態時請勿關閉雪櫃門。
(可能造成雪櫃門無法完全關上)

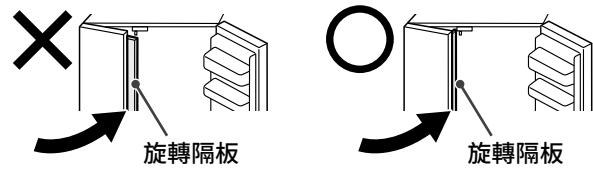

置物架、層架高度的調整

依食品或飲料的大小、置物架及層架的位置可做適度的調整。關於拆卸方式、安裝方式請參閱 **→ 28 頁**

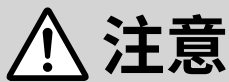

注意

■ 使用玻璃層架時

- 請勿對玻璃層架施加強力的撞擊。(玻璃層架可能破裂而導致受傷)
- 因玻璃層架較重，於安裝及卸除時請特別小心。

■ 可調式層架上段、可調式層架中段、可調式層架下段、可調式置物架

依食品或飲料的大小，可以做適度的調整。

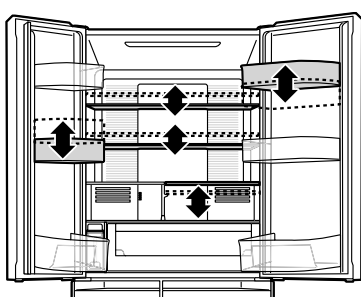

● 購買時的狀態

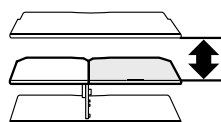

上段

● 鍋具的收納

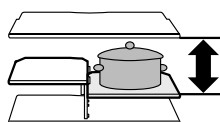

中段

● 牛奶等收納

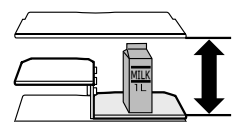

下段

-1°C特鮮冰溫室

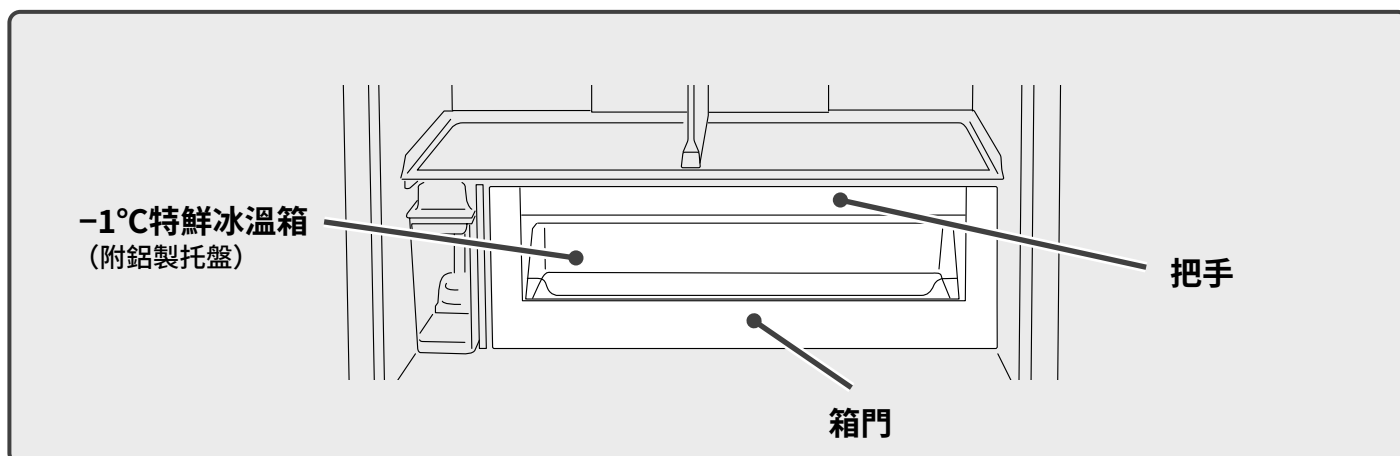
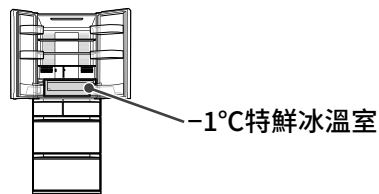

食品收納

-1°C特鮮冰溫室 (約-2°C~ 0°C)	● 肉類、肉類加工食物	● 魚類、海鮮、魚類加工食物	● 肉及魚類的解凍
			
	● 水分多的食品可能會結凍。		

注意事項

- 周圍溫度低時，水分較多的食品可能因低溫而結凍。
- 冷藏室、冰凍室的溫度設定變更後，-1°C特鮮冰溫室的溫度也隨之變動。
- 請勿將過多的食品或容器塞入-1°C特鮮冰溫室。
可能會導致 -1°C特鮮冰溫箱無法拉出。

■ 不適合存放於-1°C特鮮冰溫室的食品

以下的食品不適合冰凍，請存放在冷藏室。

● 乳製品



● 切好的蔬果



● 結凍時會造成口感變差的食品



-1°C特鮮冰溫箱的開關

開啟箱門時

請手持把手將-1°C特鮮冰溫箱往前拉出

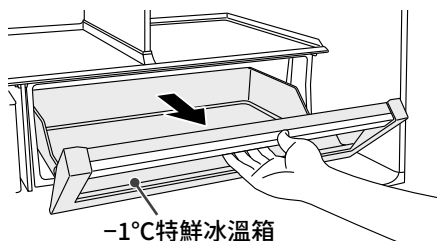

※ 在沒有同時開啟左右冰雪櫃門的狀態下直接將-1°C特鮮冰溫箱往前拉出，可能造成零件的破損。

關閉箱門時

將-1°C特鮮冰溫箱往內推進

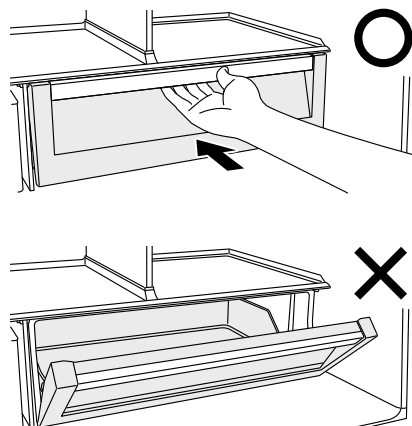

※ 請往內推進後再將冷藏室的雪櫃門關上。

注意事項

● 若不先將-1°C特鮮冰溫箱往內推進再關上冷藏室的雪櫃門，可能會造成零件及食品的破損，或是門縫間產生間隙，造成無法充分冷卻的原因。

敬請依照指示操作

- 食品和空氣中所含的水分，可能在-1°C特鮮冰溫室內結成水滴或結霜、結冰。請用柔軟的布沾溫水擦拭。（產生水滴或結霜、結冰時，並不會對冷卻性能造成影響。）
- 若您在意食品上有水滴、霜、結冰的話，建議在存放食品時，先以保鮮膜包裹再放入。
- -1°C特鮮冰溫室內若水或食品的液體溢出時，請立刻擦拭乾淨。
- 當夾到食品的包裝時，請將此包裝取下。

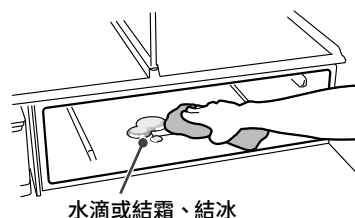

● 當打開-1°C特鮮冰溫箱時，請勿放置重物於箱門上。

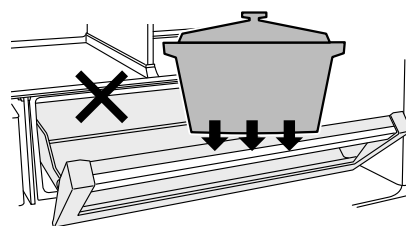

● 箱門表面的透明部分有覆上保護膜。
就這樣繼續使用的話不會發生性能故障，但若在意的話請將其取下。

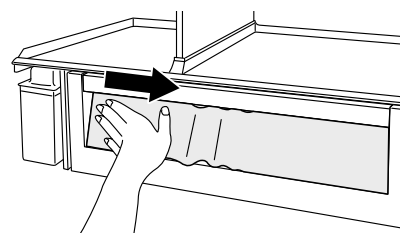

欲取下保護膜時，請如同說明圖中所表示，從旁邊往中間拉起，就可以撕掉了。

製冰室 (自動製冰機)

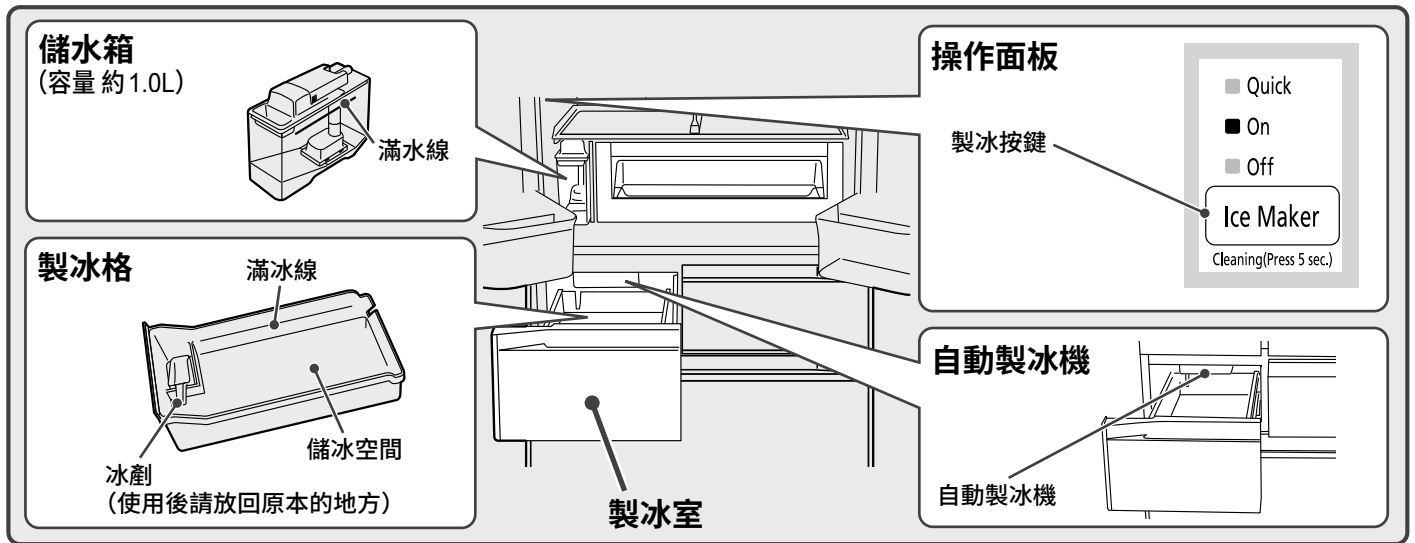
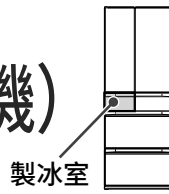

製冰方法

初次製冰時，或是一星期以上沒有製冰時，請操作「製冰機清潔」。 → 27 頁

- 1** 按下 **Ice Maker** 按鍵，「On」燈號亮起。

購買時之預始設定為「On」。

操作面板

 - Quick
 - On
 - Off

Ice Maker (Cleaning/Press 5 sec.)

燈號亮起

按下
- 2** 將給水槽往水平方向拉出。

※拿起給水槽往身邊拉，有時候會感覺到重量比較重。

把手
- 3** 打開儲水箱注入水。

※請勿加水至滿水線以上。

儲水箱蓋

滿水線
- 4** 設定儲水箱。

往前推入到超過「水槽安裝位置」的線位，確實押入底部。

確實押入底部

若儲水箱沒有確實押入底部，則無法製冰。

※儲水箱傾斜會將水灑出。水灑出請立即擦乾。

儲水箱固定位置
- 5** 自動開始製冰運轉。

 - 當冰塊積滿至滿冰線時，則會暫時停止製冰功能。當冰塊減少時，會自動啟動製冰功能。
 - 當製冰格內沒有冰塊時，從製冰盤掉落冰塊，可能有較大的聲音。

敬請依照指示操作

- 注意：只可加入飲用水。
- 製冰用水根據貴國的飲用水標準而定。自來水的水質因不同國家而異。請向地方當局檢查、核實。
- 因衛生上的理由，請至少每週更換一次水，並清洗容器。 → 26 頁
- 使用含豐富礦物質的礦泉水製作冰塊時，會產生白色的粉末，這是礦物質成分，對人體無害。
- 如下列所示，因為容易受到細菌污染，平常請三天清洗容器一次。



- 由於會導致故障，或是會造出畸形・連體的冰等，請不要使用這些(液體)。



冰的收納量、製冰時間

型號		R-HV490R 型號
冰的收納量	冰塊平整狀態	約 140 個
一次 (12 個) 的製冰時間	一般的「On」	約 110 分 ~ 140 分
	「Quick」	約 80 分

※ 周圍溫度約 30°C，冰凍室溫度設定在「Normal」，冷藏室溫度設定在「Moist Cool」的位置，無開關雪櫃門狀態的約略值。

通知事項

- 若冰塊僅堆積於一處，即使儲冰量少，也可能不再進行製冰。請將冰塊整平。

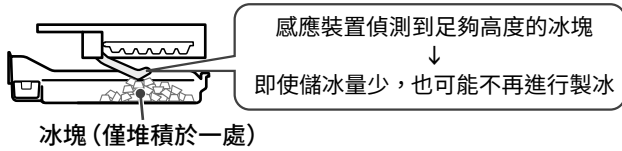

- 將冰塊整平，就可增加製冰量。

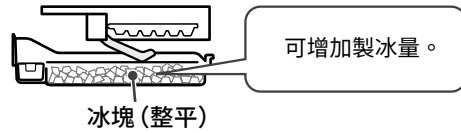

- 遇上以下情況時，製冰的所需時間可能會延長。
 - 開始使用時 (可能需要 24 小時以上)
 - 冰凍室溫度設定為「Cold」時
 - 雪櫃內同時放進大量食品時
 - 設定成「Save」時

- 雪櫃門開關次數頻繁時
- 冰凍室或製冰室門呈半開的狀態
- 冬天周圍溫度較低時
- 停電時

敬請依照指示操作

- 設定成「On」「Quick」時，儲冰空間，除了自動製冰機所製造出的冰塊外，請勿放入其他的冰凍食品或冰剉。有可能造成無法製冰。(或因食品接觸到製冰機的零件而導致門無法開啟，零件破損等情形。)
- 請慢慢的開關製冰室門。若開關時用力過猛，冰塊可能從製冰格掉落至下層冰凍室。

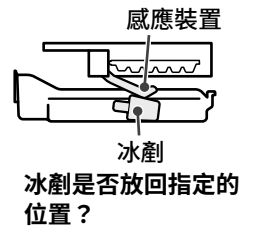
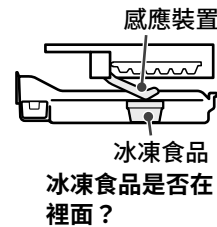

短時間內製冰

按下 **Ice Maker** 按鍵，「Quick」

燈號亮起。

約 7 小時運轉後會自動停止，
切換至「On」模式。

通知事項

- 由於「Quick」運轉時優先冷卻冰凍室，因此冷藏室門開關次數頻繁時，冷藏室的溫度容易上升。

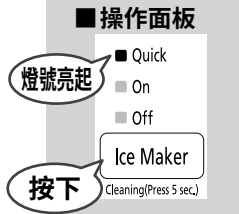

不製冰

按下 **Ice Maker** 按鍵，「Off」

燈號亮起。

※ 一星期以上設定為「Off」時，請操作
「製冰機清潔」。

→ 26、27 頁



給水警示燈

儲水箱的水量減少時，「Water」燈號亮起。請補充水至儲水箱內。

開關雪櫃左側雪櫃門時，「Water」的顯示會暫時熄滅。若沒有補充水的情況，顯示會再次亮燈。(最長是 3 小時後)

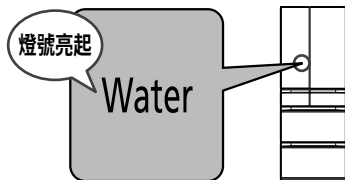

通知事項

- 自動製冰機設定為「Off」時「Water」燈號不會顯示。
- 即使儲水箱中有水，但若儲水箱沒有確實推入，「Water」顯示燈會亮起。此時請確實地將儲水箱往前推入至固定位置。
- 設定成「On」時，當滿冰的狀態時，有可能「Water」的燈號不會亮起。

Ice Maker 「On」或 **Freezer** 「Coldest/Cold」及 **Fridge** 「Cold」燈號閃爍時

製冰盤有可能碰到製冰格內的食物。
請將製冰格內清空，然後操作「製冰機清潔」。

→ 27 頁

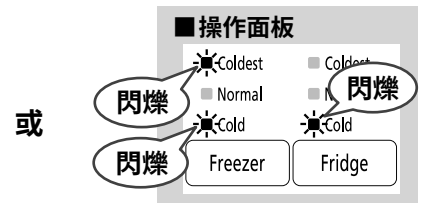

冰凍室

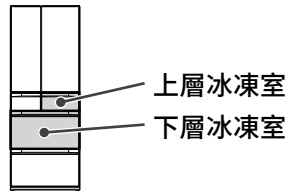

上層冰凍室

請將日常使用的食品或使用過的食品保存於此。

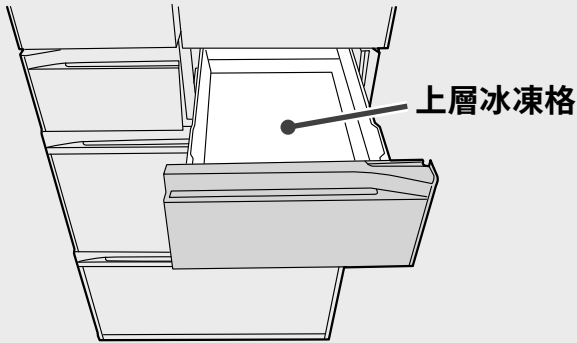

下層冰凍室

內配3層冰凍格，能夠充分地存放，整齊地收納。
適合存放需長期冰凍保存的東西，容易融化的雪糕等。

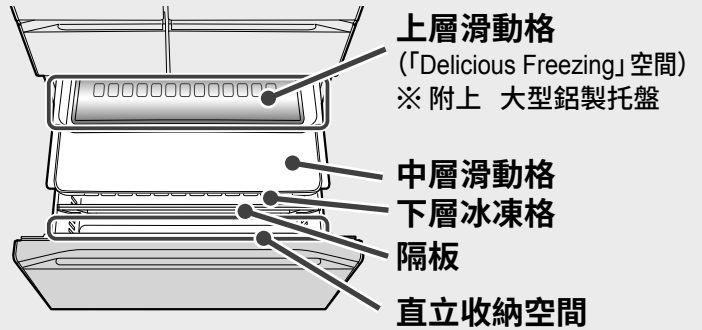

注意事項 ● 上層滑動格及隔板無法拆卸取出。

收納食品

上層冰凍室		冰凍包裝、密閉容器、吐司麵包等
下層冰凍室	上層滑動格	小件冰凍食品等 「Delicious Freezing」空間 肉類、魚類及白飯快速冰凍時
	中層滑動格	冰凍包裝、密閉容器等
	下層冰凍格	冰凍食品、雪糕等 直立收納空間 冰凍專用寶特瓶等

收納食品時

請配合食品的種類、大小來收納。收納食品的高度上限，請參考各收納格的邊高。
收納食品時，請勿堆疊碰到上面的收納格或隔板。

可能因雪櫃門沒有完全關緊，而造成不夠冷的情形。此外，也可能造成食品及盒子破損。

注意事項

- 上層滑動格內請勿放入寶特瓶。
寶特瓶結凍後膨脹，會拿不出來。
- 上層滑動格及中層滑動格請勿拆下另作他用。若食品從收納盒後面掉落，雪櫃門可能會無法關閉。
- 請只使用於存放可冰凍的寶特瓶類及能夠冰凍的食品。

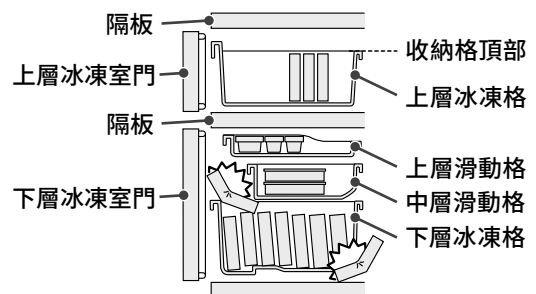

肉類、魚類及白飯快速冰凍時（「Delicious Freezing」的使用）

搭配大型鋁製托盤的效果，可更快速的冰凍食品。

將食品放置在「Delicious Freezing」空間，感測器可以感測食品的溫度，自動切換冷卻運轉。

請將食品用保鮮膜或夾鏈袋包好後再放置在鋁製托盤上。

將食品分成小包裝，不僅可快速冰凍至中心部，也便於拿取，相當方便。

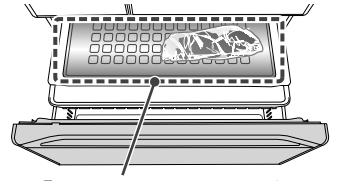

「Delicious Freezing」空間

通知事項

- 若食品不重疊地緊貼大型鋁製托盤地放置，則能夠更加有效地冰凍。

調校溫度（冰凍室）

按下 **Freezer** 按鍵，可調整溫度。

購買時之預始設定為「Normal」。通常請設定為「Normal」就可以。

若在夏天感覺冷度不夠時，請設定為「Coldest」。

敬請依照指示操作

若覺得雪櫃內太冷時，請設定為「Normal」或「Cold」就可以。

通知事項

- 雪櫃內部溫度因使用條件不同可依此變動。
- 您亦可以微細調校溫度的設定。 → **22 頁**
- 將冰凍室溫度設定為「Coldest」時比設定為「Normal」時的耗電量約增加 20%。
- 當變更冷藏室的溫度設定時，製冰室的溫度也隨之改變。

■ 操作面板

- Coldest
- Normal
- Cold

Freezer

冰凍室的大概溫度

「Coldest」比「Normal」溫度低 2 ~ 4°C

「Cold」比「Normal」溫度高 2 ~ 4°C

蔬果保鮮室

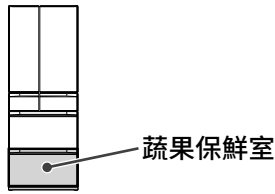

白金觸媒 將食品所散發出的氣味成分，蔬菜所散發的乙烯氣分解，轉變為碳酸氣，因而抑制食品鮮度的降低。白金觸媒不需要更換。請勿拆下。

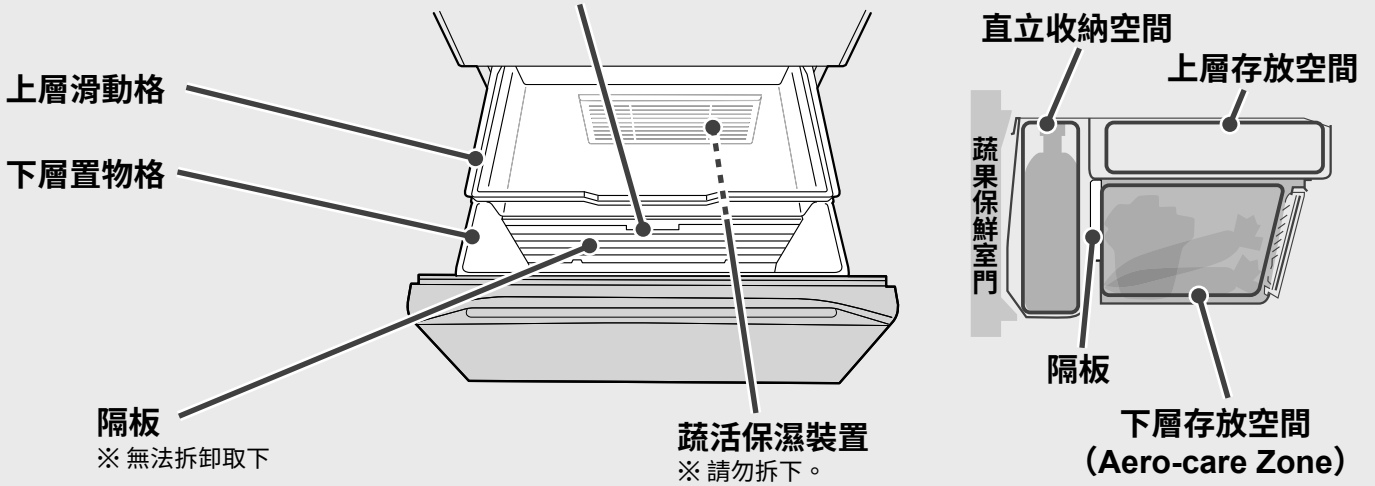

收納食品

上層存放空間	未使用完的蔬菜及小型蔬菜 (番茄、青椒等)、水果等 (草莓、葡萄柚等)
下層存放空間	葉菜類 (菠菜、小松菜等) 及大型蔬菜 (高麗菜、生菜等) 等
直立收納空間	較大株的蔬菜 (青瓜、蘆筍等)、2L 的寶特瓶等

收納食品時

請配合食品の種類及大小進行收納。

- 請注意收納食品的高度。
 - 雪櫃門無法確實關緊，可能造成冷卻效果變差。此外，也可能造成食品及各格子的破損。
 - 因寶特瓶的種類不同，有可能過大而至無法收納。
- 上層滑動格請勿拆下後另作他用。
 - 食品可能會從置物格的後面掉落而導致門無法關緊。
- 請勿將過量的食品，飲料等強硬塞入。
 - 可能造成隔板及各收納格的破損。

高度的基準

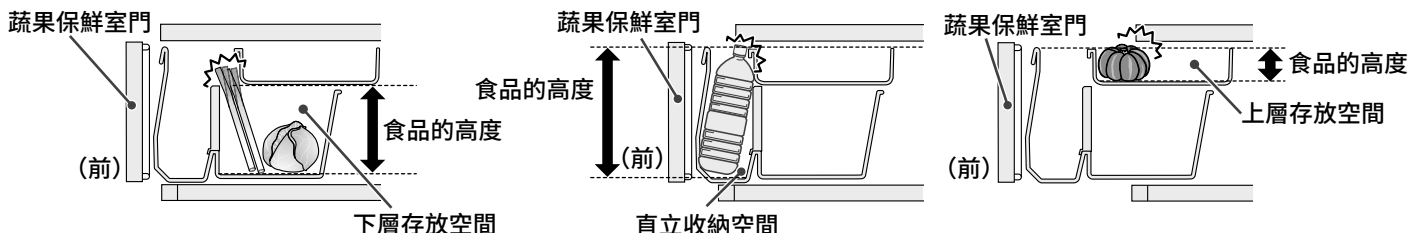

調校蔬果保鮮室的溫度(使用「蔬果室強」)

設定方式

購買時設定成「關」的狀態。

按下 **Powerful** 按鍵，「Veg」燈號亮起。

以比平常更低的溫度來保存。(一般約4 ~ 8°C → 「Veg」約2 ~ 6°C)

※ 雪櫃周圍溫度32°C，冷藏室、冰凍室的溫度都設定在「Normal」，且放入食品關閉雪櫃門，安定運轉時的大致溫度。

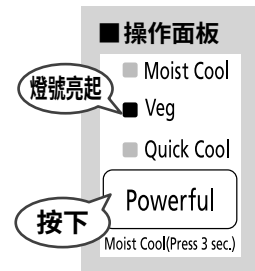

中途解除時

按下 **Powerful** 按鍵，「Veg」燈號熄滅。

通知事項

- 長時間使用「Veg」功能時，含水分較多的蔬菜有可能會結凍。請解除「Veg」的設定。
- 在「Veg」模式中，設定成「Save」模式時，冷卻效果會由「Veg」轉為較弱的冷卻效果。 → 24頁
- 當外面溫度較低時，蔬果保鮮室內的溫度可能會變低。

敬請依照指示操作

若有以下的情形，請解除「Veg」的設定。

- 擔心茄子等較不耐低溫的蔬菜表面呈現凹陷、變色的情形時。
- 擔心蔬果保鮮室有結露的情況時。

蔬果保存時的訣竅

■ 建議以常溫保存的蔬果

- 大蒜、洋蔥、馬鈴薯、番薯和南瓜(整顆)建議保存在陰冷處(室內恆溫且不受陽光直射的地方)。



■ 溫度過低食品有可能受到傷害

長期放在蔬果保鮮室內，因食品種類而異，可能會發生變色或風味減低的情況。此外，也有可能發生維他命C含量降低，發霉或腐敗的情況。

- 蔬菜... 茄子、青椒、小黃瓜、茄子、四季豆、番薯、秋葵等



- 水果... 蕉、菠蘿、芒果、木瓜、牛油果、檸檬等



食用前可先暫放至雪櫃，稍微冰鎮後更好吃。

收納提示

- 收納較少蔬菜時，因為無法保持較高的濕度，請用保鮮膜包裹後再存放。
- 因為蔬果保鮮室的濕度較高，依蔬菜的量及種類不同，可能在置物格，蔬活保濕裝置及食品表面出現結露的情況。若想避免結露，請使用保鮮膜包裹食品。
- 因食品包裝袋及容器擋住蔬活保濕裝置時，會出現更多的結露情況。請將擋住蔬活保濕裝置的食品包裝袋及容器移放至其他地方。
- 置物格內若留存水分，食品容易受損，請用軟布將水分拭乾。
- 米、海苔等的乾燥食品收納於蔬果保鮮室時，請裝入密閉的容器(袋)後再放入蔬果保鮮室內。乾燥食品容易吸收濕氣。

通知事項

直立收納空間比其他空間的溫度設定稍高。

各種功能

溫度微調節 (冷藏室、冰凍室)

冷藏室和冰凍室的溫度設定可再細分為 11 個階段。

- 1 開啟冷藏室門及下層冰凍室門。
- 2 連續按住 **Fridge** 按鍵 5 秒以上，直到發出嗶聲為止。
- 3 關閉下層冰凍室門。
- 4 按下 **Fridge** 或 **Freezer** 按鍵，可調節各室的溫度。

按下按鍵，如下圖所示依序切換。
平常請設定在「Normal」的位置。

(■: 燈亮、●: 閃爍、□: 熄滅)

表示	□ Coldest	□ Coldest	□ Coldest	□ Coldest	□ Coldest	□ Coldest	■ Coldest	■ Coldest	■ Coldest	■ Coldest	■ Coldest
	□ Normal	□ Normal	■ Normal	■ Normal	■ Normal	■ Normal	■ Normal	■ Normal	■ Normal	■ Normal	■ Normal
	■ Cold	■ Cold	■ Cold	■ Cold	■ Cold	■ Cold	■ Cold	■ Cold	■ Cold	■ Cold	■ Cold
設定	更弱	弱	→	→	→	中	→	→	→	強	更強

操作面板

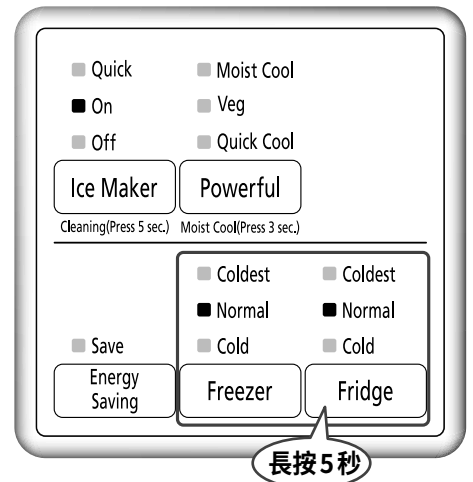

解除

- 依照 1、2、3 順序操作。
操作音嗶嗶聲響起，便回到一般的調節 (3 階段)。

eco 運轉顯示燈

在運轉穩定時 **eco** 燈號會自動亮燈，表示現在正進行節能源運轉。
減少雪櫃門的開關次數及盡量縮短每次開啟的時間，來作為使用時的參考。

通知事項

eco 無法亮燈時，可能是以下的原因。

- 剛設置完成後，或一次儲放大量的食品時
- 雪櫃門開關次數頻繁時
- 當食品或包裝袋被雪櫃門夾住，及雪櫃門未關緊時
- 設定為「Quick」「Quick Cool」「Veg」時
- 雪櫃周圍溫度達到 35°C 以上時

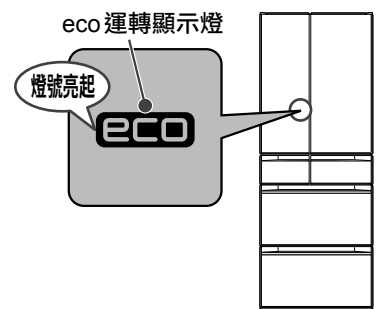

雪櫃門警報器

任何一個門打開 1 分鐘以上時，會以聲音來警示雪櫃門處於開啟的狀態。

僅於冷藏室、製冰室及下層冰凍室，設有防止雪櫃門打開之警報功能。(上層冰凍室及蔬果保鮮室則無設置)

雪櫃門的打開時	30 秒後 (設定為省電模式時)	1 分鐘後	2 分鐘後	3 分鐘之後
警報聲音	嗶—(3 次)	嗶—(3 次)	嗶—(5 次)	嗶—(連續) 大音量
操作面板燈號	—	—	—	閃爍

通知事項

操作面板的燈號閃爍時，縱使按下按鍵也沒有反應。請將雪櫃門關閉後再進行操作。

雪櫃門警報器及操作聲音的音量調節

雪櫃門警報器及操作音可設定為更大音量，也可以設定為靜音。

購買時設定成「標準」的狀態。

連續按住 Fridge 按鍵 3 秒以上，直到發出設定音為止。

操作聲音的音量可切換成「標準」「較大」「靜音」。設定的切換依照此順序輪替，請依個人需求切換設定聲音。(參照下表)

音量	標準	較大	靜音	標準
設定聲音	—	嗶—嗶—	嗶—	嗶嗶

(購買時)

通知事項

- 雪櫃門警報器或操作聲音，無法只調整任何一方的音量。
- 設定為不發出聲響時，雪櫃門警報器顯示燈的閃爍也會停止。
- 即使音量設定為「靜音」時，「製冰機清潔」的警報器也會發出聲響。
此外，如果連續按住按鍵 3 秒以上，按完就會發出設定音效。→ 27 頁
- 當拔除電源再插上插頭時，或停電後恢復供電時，雪櫃門警報聲音則恢復到原來標準狀態的設定。

三重除臭過濾 (冷藏室)

利用三種除臭素材的組合，有效地捕捉並去除雪櫃內含有硫磺系、氮系、醛系、酸系等四大異味分子。

省電

省電模式

設定為省電模式時，將各冷藏室的冷卻調弱，可達到省電目的。

開啟冷藏室門達30秒以上時，雪櫃門警報器發出聲響，冷藏室的LED燈之亮度會減弱，藉此告知盡量縮短雪櫃門開關的時間。此外，長時間未開關雪櫃門時，雪櫃內部會緩慢冷卻，可更加抑制電力消耗。

設定時

購買時，設定成省電模式「關」(熄滅)的狀態。

按下  按鍵，「Save」燈號亮起。

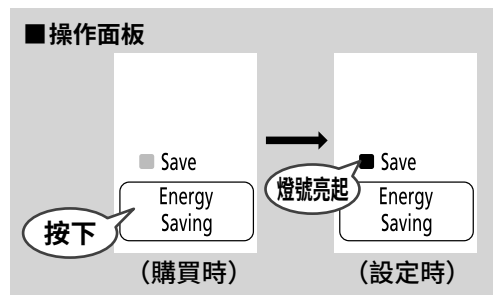

解除時

按下  按鍵，「Save」燈號熄滅。

通知事項

- 將冷卻轉換為弱的時候，雪糕會變軟，可能覺得冷卻程度不夠。此外，冰凍食品有可能會結霜，食品凍結時間及製冰也比一般時間長。
- 「Save」中設定為「Quick」或「Quick Cool」時，冷卻轉弱的運轉會暫時解除。
- 「冰凍室」「冷藏室」雙方或任一方的溫度設定在「Cold」的時候，為了維持各存放室內的食品的新鮮度，冷卻效果則不會轉弱。
- 「Save」與「Veg」同時設定時，冷卻從「Veg」轉成較弱的冷卻效果。 → 21頁

保養方法



警告

清潔時，請務必把電源插頭從插座拔掉。

■發現骯髒時

立即擦乾淨。看不到的部分也請一年清潔一次。

電源插頭

將電源插頭從插座拔出，以乾布擦拭灰塵等。

為了防止火災及觸電 → 4頁

一年一~二次



雪櫃門密封墊

請以軟布沾溫水擦拭。

由於此部分易髒，請擦乾淨。

一個月一次

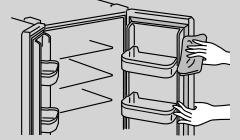

雪櫃門表面

一個月一次

雪櫃門表面請以柔軟的布，沾溫水將污垢擦拭後，再用乾布拭淨。

玻璃表面有膠布黏膠殘留時，可以塑膠橡皮擦擦後，再用乾布擦拭乾淨。

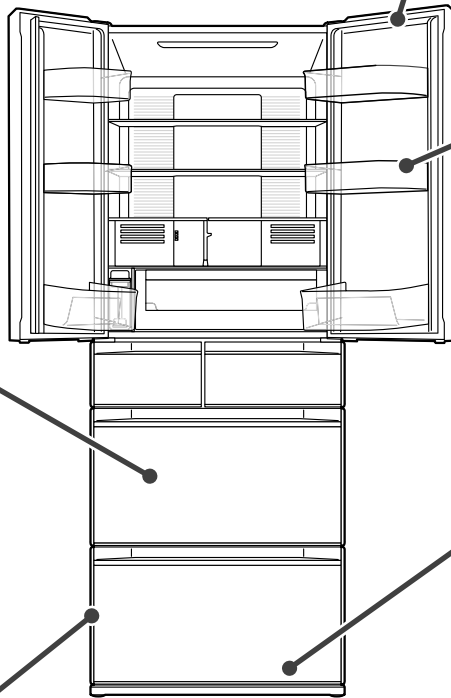
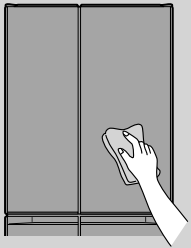

各層架

三個月一次

置物架

請以軟布沾溫水擦拭。

卸除方法請參閱 → 28頁

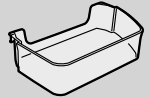

液體承接處

一個月一次

請以軟布沾溫水擦拭。

積聚液體時，請擦拭乾淨。

液體接收處

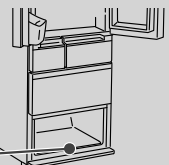

雪櫃背面、側面、地板

一年一~二次

拆除腳座護蓋，將調節腳稍微抬起，把雪櫃往身前方向拉出，擦拭污垢。

卸除方式請參閱 → 8頁

塑膠部件(左右)
※請勿拆卸

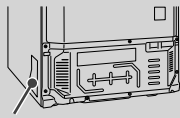

- 背面及側面下方的塑膠部件周圍，由於空氣對流的關係，容易堆積灰塵形成髒污。若為容易刮花的地板，請鋪上保護用板等。
- 若在意雪櫃的震動音，或因濕氣而導致背面牆壁變色或髒汙時，請將雪櫃設置在距離牆壁(2cm以上)的地方。

置物格

三個月一次

請以軟布沾溫水擦拭。

用水清洗蔬果保鮮室的下層置物格時，請倒置讓水滴乾後，並用乾布充分擦拭乾淨。此外請勿使用牙刷，洗碗刷等長刷毛之刷子清洗。可能會造成置物格及蔬活保濕裝置破損。

卸除方法請參閱 → 29頁

※請勿用水清洗白金觸媒。

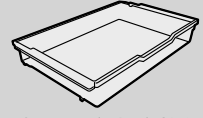

敬請依照指示操作

- 由於可能會造成雪櫃門、塗裝面、塑膠、玻璃面受損或變色，請勿使用以下清潔用品。

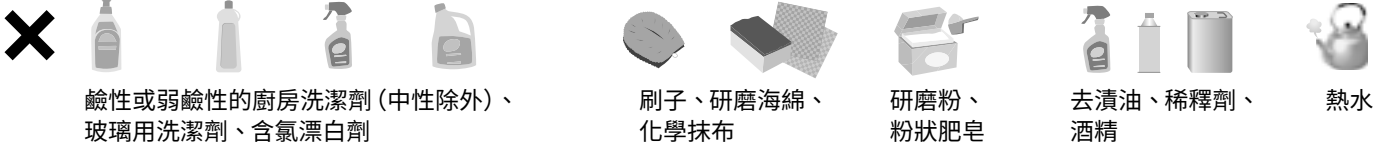

鹼性或弱鹼性的廚房洗潔劑(中性除外)、
玻璃用洗潔劑、含氯漂白劑

刷子、研磨海綿、
化學抹布

研磨粉、
粉狀肥皂

去漬油、稀釋劑、
酒精

熱水

請確認洗潔劑上「根據家庭用品品質表示法表示」的「液性」欄。

- 沾到食用油、柑橘類的果汁、食品液體時，請務必擦拭乾淨。因其可能引起附著處的損傷與變色。
- 因置物格或滑動櫃的軌道接觸面上塗抹了潤滑劑，保養時請勿擦拭。(潤滑劑是符合食品衛生法)
- 磁鐵裝飾或是吸盤吸附在雪櫃本體的側面或雪櫃門表面時，有可能會在表面留下痕跡。
- 拔除電源插頭時，操作面板上設定的功能會被解除，請根據需要再次進行設定。

保養方法 ~續前頁~

-1°C特鮮冰溫室 一個月一次

1 拉出-1°C特鮮冰溫室。

卸除方法請參閱 → 28頁

請務必先取出原本保存在-1°C特鮮冰溫室內的食物。

2 以下的零件，請以沾溫水的軟布擦拭。

※ 請勿使用洗潔劑。

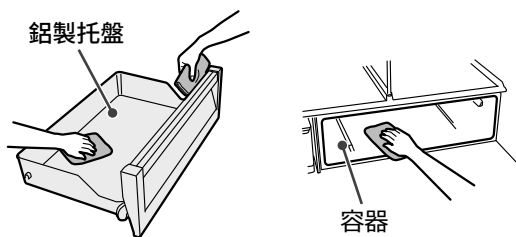

3 安裝-1°C特鮮冰溫室。

安裝方式請參閱 → 28頁

儲水箱 每周一次

1 取出儲水箱，卸除水箱蓋。

- 1 水箱蓋往箭頭指示的方向傾斜。
- 2 將水箱蓋前側往上傾。

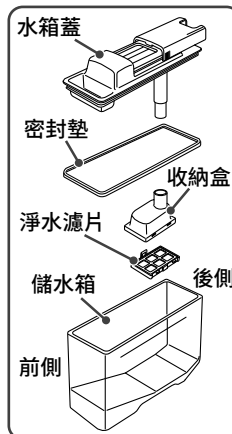
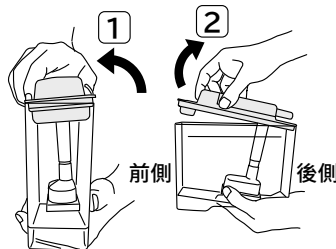

2 從蓋子處將密封墊及收納盒拆卸下來。

拉出收納盒從蓋子處拆卸下來。

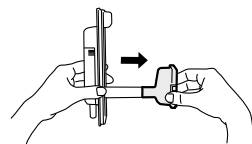

3 從收納盒將淨水濾片拆卸下來。

拉住淨水濾片的扣勾，從倒勾處卸下後卸除箱盒。

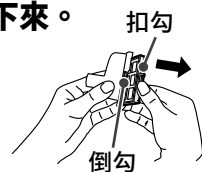

4 以水清洗儲水箱各零件。

以柔軟的海綿等用水洗乾淨。請不要使用洗潔劑等。

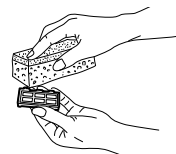

通知事項

- 淨水濾片約3~4年更換一次。 → 36頁

5 組裝好儲水箱的各部零件後，加入水後再裝上。

蓋子與箱盒合上凸部後再插入。

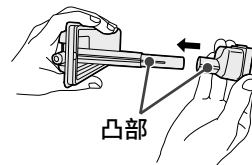

請從水箱蓋的後方插入，往箭頭方向關上。

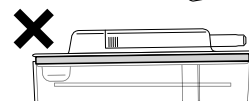
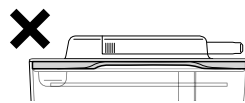
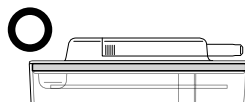

敬請依照指示操作

自動製冰機長期未使用時，請將儲水箱洗淨後，充分乾燥後，再裝入原來的位置。
(特別是淨水濾片請務必充分乾燥)

製冰機清潔

初次使用時

自動製冰機一星期以上沒有使用時



警告

請勿將手放入自動製冰機內的零件部分
(會有受傷的危險)

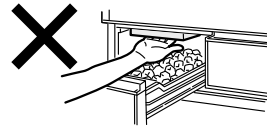

以水來沖洗製冰盤及給水管路。

準備

操作前請確認以下事項。

儲水箱

- 裝水至滿水線。
- 正確安裝於超過儲水槽的位置上。

製冰格

- 有殘留冰塊時請清除。

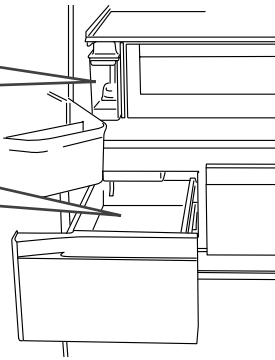

確認後，請關上冷藏室以外的雪櫃門，再繼續操作下一個步驟。

1

連續按住 **Ice Maker** 按鍵5秒以上，直到發出警示聲為止。

「Quick」「On」「Off」三個顯示燈號同時閃爍時，「製冰機清潔」就開始運作。(約4分鐘)

- 請關上冷藏室門。
- 約4分鐘內，顯示燈號會不停閃爍，警報音效也會持續發出。
- 「製冰機清潔」功能運轉時，無法中途停止。
- 「製冰機清潔」功能運轉時，若打開雪櫃任何一個門，則可能無法正常運作。製冰機清潔運轉結束前，請不要開啟雪櫃門。
- 即使原本雪櫃門警報器設定為停止的狀態，也會發出聲響。 → 23頁

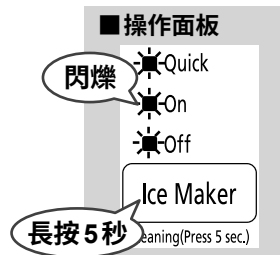

2

警示聲響及顯示燈停止閃爍後，將乾淨的毛巾以塞住製冰格內部缺口的的方式，並鋪在製冰格的底部。

鋪上毛巾的目的是由於製冰機清潔功能運轉時積在內部的水會從製冰格缺口流出，因此鋪上毛巾吸收流出的水。

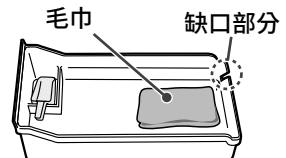

3

將製冰格拆卸下來，擦拭乾淨積水後重新安裝在製冰室內。

- 請取出擦拭積水的毛巾。
- 儲水箱裡剩下的水，還可以繼續使用。
- 「製冰機清潔」結束後，自動設定回「On」。

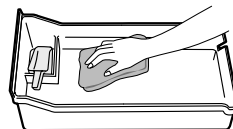

卸除組件的方法、安裝的方法

注意事項

- 卸除零件時，請先將放在零件上的食品移除。
- 請勿拆除此處未說明的零件。
- 想要卸除說明書上未說明的零件進行清潔等時，請向技術中心諮詢。 → 76頁
- 請勿拆除蔬果保鮮室的白金觸媒。並且請勿以水沖洗。

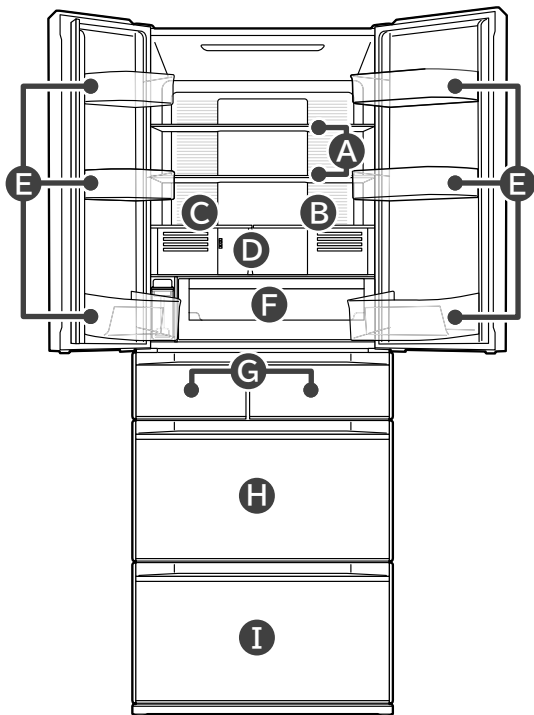

A 可調式層架上段、中段

敬請依照指示操作

卸除層架時，請先卸除上層再卸除下層。
安裝層架時，從下面的層架開始安裝。

- 1 把層架內側稍微抬高，往前拉出。
- 2 如圖示將棚架直立。
- 3 讓其迴轉後拆除。

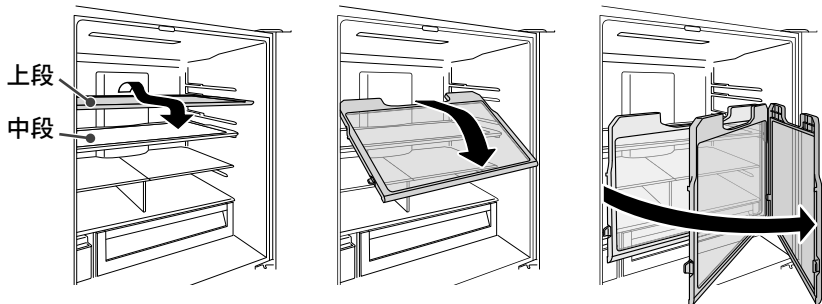

注意事項

因玻璃層架較重，安裝及卸除時請特別小心。掉落時可能會被撞傷或是因破裂而被刮花。

B 可調式層架下段

稍微抬高並取下。

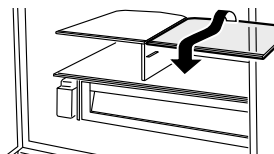

C 固定層架

一邊壓著棚架一邊將層架內側稍微抬高，往前拉出。

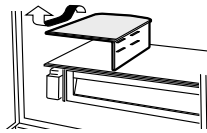

這時請先將可調式層架下段拆卸下來。

D 棚架

- 1 扶住後側並讓其迴轉。
- 2 一邊往後壓，一邊拆卸取下。

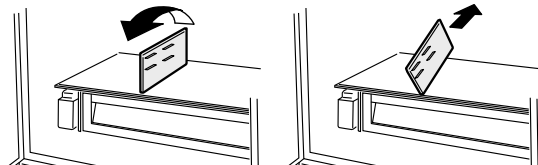

E 雪櫃門置物架

一邊輕敲底部左右，一邊提高便可卸取。

(牢固地固定)

注意事項

安裝時，請確實安裝至最後面。如安裝不牢固就會掉落，可能會受傷。

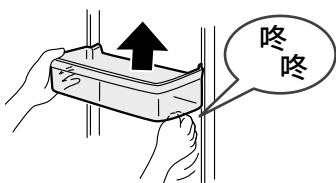

F -1°C特鮮冰溫箱

卸除方法

拉出-1°C特鮮冰溫箱，輕輕拿起前面，斜斜的拉出。

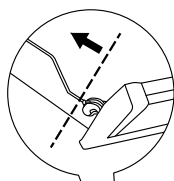

注意事項

欲拿取-1°C特鮮冰溫箱時，請沿著線扶住後側再取出。手指有可能有被箱門夾傷的危險。

注意事項

欲拆除-1°C特鮮冰溫箱時，請勿只扶住箱門或把手，而是確實拿好整個盒子再行拆除。不然可能導致滑動盒的零件破損。

安裝方法

讓真-1°C特鮮冰溫箱的左右突起順著容器的導引軌道滑動推入。最後再將把手往下扳到底鎖住。

敬請依照指示操作

安裝好後請試著拉出推進幾次，確認是否安裝正確。

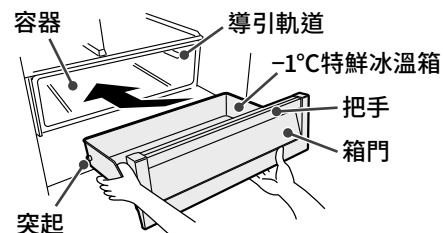

G 製冰格 (製冰室)、上層冰凍格 (上層冰凍室)

打開門，向前方取出。

安裝時，請將格子底部裝載在框架上。

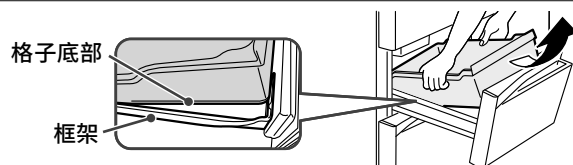

H 中層滑動格、下層冰凍格 (下層冰凍室)

1 打開門後，拉出中層滑動格。

2 將下層冰凍格往前抬起。

注意事項 ● 上層滑動格無法拆卸。

注意事項 ● 隔板無法拆下。

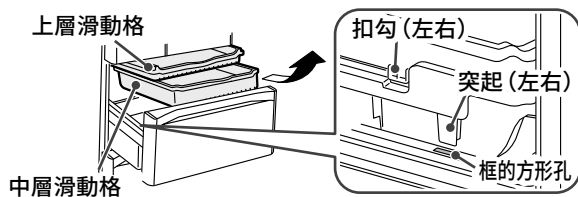

● 中層滑動格請安裝至後面寫著「REAR」文字的地方。若安裝不正確，會造成雪櫃門開關時的異常聲音及雪櫃門無法關緊。

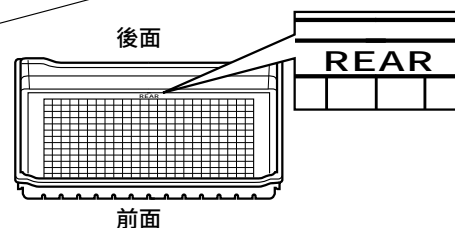

安裝時，請將下層冰凍格的左右突出部分，插入門框兩旁的洞固定。另外也請將中層滑動格兩旁的扣勾插入下層冰凍格的外側固定。

I 上層滑動格、下層置物格 (蔬果保鮮室)

1 將雪櫃門往身前打開，手持兩端往上抬起，慢慢往拉出，放在地板上。

2 將上層滑動格拉起。

3 下層置物格朝身體方向往上抬起。

注意事項 ● 隔板無法拆下。

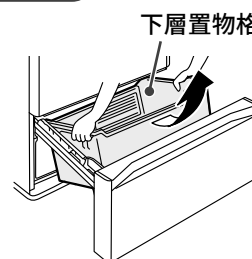
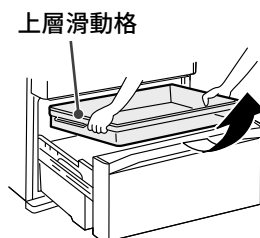
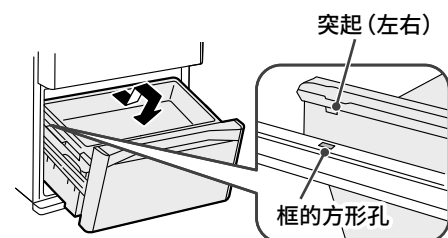

注意事項 ● 開門時請留意勿將腳靠近雪櫃門。腳有可能被門夾傷。
● 請注意，積水可能會從下層置物格背面流出。

若安裝不正確，會造成雪櫃門開關時的異常聲音及雪櫃門無法關緊。

通知事項 ● 若上層滑動格未正確安裝時，可能導致滑動格的零件破損。安裝後，請試著將上層滑動格前後滑動，以確認是否安裝正確。

拉取式門的安裝方法 (製冰室、上層冰凍室、下層冰凍室、蔬果保鮮室)

製冰室、上層冰凍室

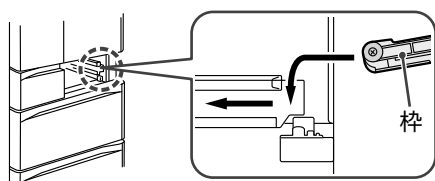

下層冰凍室、蔬果保鮮室

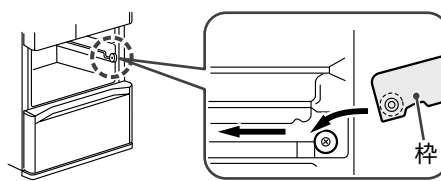



遇到問題時

在委託修理之前，請再次檢查以下幾點。若仍無法解決時，請聯絡購買的經銷商或敝公司技術中心。 → 76頁

問題描述		請確認	請依照指示這樣做 / 理由
初次使用時	不冷	設置好後是否未達24小時？	設置後至完全冷卻需24小時。存放食品間請保留間隙，並儘量減少雪櫃門開關次數，並耐心等待。 此外，在夏天及食品大量存放時，至完全冷卻需更多時間。
	無法製冰	設定後是否未達24小時？	設定後，因雪櫃未完全冷卻，到可以製冰需要24小時以上。存放食品間請保留間隙，並儘量減少雪櫃門開關次數，並耐心等待。
不冷 雪糕變軟	不夠冷 雪糕變軟	食品或袋子是否被夾住，雪櫃門未關緊？	請除去被夾住的食物，確實關緊雪櫃門。還有收納的時候請注意食品存放的高度限制。
		是否塞入過多食品，一次放入了大量的食物呢？	食品間請保留間隙存放。
		各存放室的盒子是否確實地安裝？	請正確安裝好。 → 29頁
		依雪櫃的設置場所及空隙、周圍狀況等，有可能會有不容易冷卻的情形。	請確認是否已正確安裝。 → 8頁
		是否設定為省電模式？	請解除省電模式的設定。 → 24頁
		是否溫度設定在「Cold」？	在不太容易降溫的地方，請變更溫度設定。 → 12、19頁
		在夏季等，雪櫃周圍的溫度高嗎？	
		是否長時間開啟雪櫃門，或頻繁地開關雪櫃門？	雪櫃門打開時，雪櫃內的溫度會逐步上升。頻繁地開關或是長時間打開雪櫃門的話，雪櫃內的溫度會難以下降。請盡量縮短開關的時間並減少雪櫃門的開關次數。
操作部的顯示是否依次改變？	由於設定為店面專用模式，請解除此設定。 → 32頁		
結霜或結露	雪櫃內及滑動格的框架上出現結霜、結露及結冰	冷藏室門或拉取式門是否未完全關緊？	關上滑動格或雪櫃門時，請確實確認是否夾到食品或包裝袋，請確實關緊。
		是否長時間開啟雪櫃門，或頻繁地開關雪櫃門？	當雪櫃門開關時，可能因空氣中的水分變成霜、冰，凝結在冰凍室的壁面或零件上。請盡量迅速開關雪櫃門，並減少開關的次數。此時請以乾布將霜、露水擦拭乾淨。
	雪櫃的外側結露	雪櫃周圍的濕度是否過高？	下雨天等室內濕度高時可能產生結露。此時請以乾布將露水擦拭乾淨。
		溫度是否設定在「Coldest」？	溫度設定為「Coldest」時，雪櫃門表面可能會有結露情形。請將溫度設定為「Normal」。請以乾布將露水擦拭乾淨。 → 12、19頁
雪櫃背面及牆壁結露	是否雪櫃周圍的濕度變高、雪櫃背面和牆壁間間隙變小？	請和雪櫃背面距離2cm以上。 → 8頁	
冷藏室中結露	是否長時間開啟雪櫃門，或頻繁地開關雪櫃門？	雪櫃門的開關次數頻繁時，或雪櫃周圍溫度高時，壁面會起霧及在冷氣出風口附近結露。非故障狀況。此時請以乾布擦拭乾淨。 	

問題描述	請確認	請依照指示這樣做 / 理由
無法製冰	操作面板的「Off (製冰停止)」顯示燈號有亮起嗎？設定到停止製冰了。	請設定為「On」或「Quick」。 → 16、17 頁
	門上的「Water」顯示燈號有亮起嗎？是否儲水箱的水變少了？	請加水至儲水箱裡。 → 16、17 頁
	儲水箱的水變少了嗎？	若水量變少則可能無法製冰。請試著加水至儲水箱的滿水線。 → 16 頁
	儲水箱是否確實推入內部並超過「水槽安裝位置」線？	請將儲水箱確實推入內部並超過「水槽安裝位置」線。 → 16 頁
	製冰格中是否放入冰塊以外的東西？	請從製冰格中取出。
一直無法製冰	冰塊是否部分超出滿冰線？	請將冰塊整平。 → 17 頁
	是否頻繁地打開雪櫃門，一次存放了大量的食物呢？	雪櫃內無法充分冷卻。在雪櫃內充分冷卻前，請盡量減少開關雪櫃門。存放食品間，請保留間隙。
	是否雪櫃周圍的溫度變低？	冬天，到可以製冰需要4小時以上。請盡量減少雪櫃門開關次數，並耐心等待。
	是否剛從「Off (製冰停止)」改為「On」的設定？	剛變更設定後，可能需要更多時間。請盡量減少雪櫃門開關次數，並耐心等待。
	食品或袋子是否被夾著，冰凍室或製冰室門是否未關緊？	請除去被夾住的食物，並確實關緊雪櫃門。
	是否設定為省電模式？	請解除省電模式。 → 24 頁
冰塊有凸起	_____	製冰盤溝槽裡有凍結的積水。非異常狀況。
所儲存的冰塊變圓 冰塊互相粘在一起	是否堆積了原本舊的冰塊？	舊的冰塊會變小，且會粘在一起。若只用冰剷就能將冰塊分開的話，就沒有什麼問題。
	是否頻繁地開關雪櫃門，一次存放了大量的食物呢？	請盡量迅速開關雪櫃門，並減少開關的次數。
	冷藏室門或拉取式門是否未完全關緊？	關雪櫃門時，請確實關緊。
製成的冰塊變小	是否儲水箱的水變少了？	當剩餘的水變少時，製冰機可能會製出較小塊的冰塊。請加水至儲水箱的滿水線。 → 16 頁
製成粘在一起的冰塊	_____	製冰盤溝槽裡有凍結的積水並與結成的冰塊互相粘在一起。非異常狀況。
冰塊裡出現白色混濁	_____	因水中的氣泡被封在冰塊裡了。
	是否使用礦泉水製冰嗎？	水中的礦物質結凍造成變白且混濁，食用上則無問題。
不進行製冰時	_____	請設定成「Off」。 請參考「不製冰」。 → 17 頁

遇到問題時 ~續前頁~

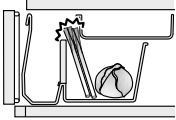
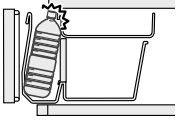
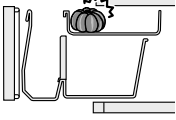
問題描述	請確認	請依照指示這樣做 / 理由						
操作面板燈號閃爍	「Save」、冰凍及冷藏「Coldest/Normal/Cold」共七個燈號正在閃爍，請逐一關上顯示燈號並進行確認。	請將閃爍的燈號做上☑記號並與日立服務中心。 → 76 頁 請詳細紀錄並正確傳達給客服人員。 <div style="border: 1px solid black; padding: 5px; margin-top: 10px;"> <p style="text-align: center;">(確認表)</p> <table style="width: 100%; border-collapse: collapse;"> <tr> <td style="width: 33%;"><input type="checkbox"/> Coldest</td> <td style="width: 33%;"><input type="checkbox"/> Coldest</td> </tr> <tr> <td><input type="checkbox"/> Normal</td> <td><input type="checkbox"/> Normal</td> </tr> <tr> <td><input type="checkbox"/> Save</td> <td><input type="checkbox"/> Cold</td> </tr> </table> <div style="display: flex; justify-content: space-around; margin-top: 5px;"> <div style="border: 1px solid black; padding: 2px 5px;">Energy Saving</div> <div style="border: 1px solid black; padding: 2px 5px;">Freezer</div> <div style="border: 1px solid black; padding: 2px 5px;">Fridge</div> </div> </div>	<input type="checkbox"/> Coldest	<input type="checkbox"/> Coldest	<input type="checkbox"/> Normal	<input type="checkbox"/> Normal	<input type="checkbox"/> Save	<input type="checkbox"/> Cold
	<input type="checkbox"/> Coldest	<input type="checkbox"/> Coldest						
	<input type="checkbox"/> Normal	<input type="checkbox"/> Normal						
	<input type="checkbox"/> Save	<input type="checkbox"/> Cold						
	在製冰室內除了自動製作的冰塊之外，是否放入其他的食物或冰塊？	有可能是食品等碰到製冰盤。請先將製冰室內清空，再操作「製冰機清潔」。 → 27 頁						
是否觸按  按鍵長達 5 秒以上。	正在進行製冰機清潔。約 4 分鐘後燈號的閃爍就會停止。顯示燈閃爍時，請勿打開雪櫃門。							
是否雪櫃門開啟中？ 是否雪櫃門夾住食品，或未確實關緊？	若雪櫃門為開啟狀態，請關上雪櫃門。 若雪櫃門夾住食品或未確實關緊，請除去被夾住的食物，並將雪櫃門確實關緊。							
閃爍的燈號不停變換	由於設定為店面專用模式，請解除設定。 店面專用模式時，無法進行冷卻運轉。 打開冷藏室門(左右)、下層冰凍室門。 按下任何一個設定顯示按鍵後，並連續按住  按鍵 10 秒以上，直到發出嗶嗶聲響。 數秒內所有的顯示燈號亮起，店面專用模式即解除，冷卻運轉開始。 關閉冷藏室門(左右)、下層冰凍室門。							
蔬果保鮮室的問題	是否存放了大量含水多的蔬菜？	因為蔬果保鮮室比其他保存室的濕度高，會因蔬菜的存放量及種類，而在蔬果保鮮室的頂部、食品的表面產生結露的情形。非異常狀況。若在意結露的情形，建議將食品先以包鮮膜包裹後再放入。此外，結露變多時，蔬果保鮮室的存放盒內可能會積水。請以乾布將積水擦拭乾淨。						
	蔬果保濕裝置是否被食品的外袋或容器所阻塞？	蔬果保濕裝置一旦被阻塞，就容易發生結露。請將阻塞在蔬果保濕裝置的食品外袋或容器移至他處。請以軟布將結露擦拭乾淨。						
	上層滑動格與下層置物格間是否夾有食品等異物？ 	請除去被夾住的異物。						
是否有寶特瓶或食品碰觸到上層滑動格的把手？ 	存放時請勿讓寶特瓶或食品碰觸到把手。							
是否有食物等異物被夾在上層滑動格及蔬果保鮮室上方間？ 	請除去被夾住的物品。 此外，請勿在食品接觸到蓋子的狀態下，硬將雪櫃門關上。							

	問題描述	請確認	請依照指示這樣做 / 理由
-1°C特鮮冰溫室的問題	-1°C特鮮冰溫室的內部或-1°C特鮮冰溫箱的周邊有水滴或結霜、結冰	是否存放了含水多的食物？	<p>由於-1°C特鮮冰溫室為密封狀態，若存放水分較多的食品時，水會凝結成露水或結霜。水分較多的食品建議先以保鮮膜包裹後再放入。若附著了水滴或結霜，請以軟布用溫水擦拭。</p>  <p>水滴或霜</p>
雪櫃門高低不平衡以及歪斜	左右雪櫃門高低不平衡 雪櫃門歪斜	設置的地點是否呈水平？	性能上沒有問題，可以照舊使用，但若介意的話，可嘗試調整左右的調節腳看看。 → 8頁
		是否由於地板材質太軟再加上儲放物的重量使雪櫃腳下沉？	雪櫃傾斜的時候，請鋪上厚度1cm以上的堅固板子。
有異味	有塑膠味	——	由於雪櫃內使用了較多的塑膠零件，完全冷卻後味道自然會不見。非異常狀況。
	冰塊有異味	儲水箱、淨水濾片髒了嗎？冰塊放太久了嗎？	為了防止「發黏」「水垢」，請定期清洗。 → 26、27頁
		——	由於自來水中的氯元素凝縮，氯的氣味變的較重。
雪櫃內有異味	是否直接地存放了氣味重的食品呢？	除臭功能無法完全去掉所有的氣味。請用保鮮膜等密封後存放。	
太冷凍結	太冷凍結	溫度設定過「Coldest」了嗎？	請設定為「Normal」。 → 12、19頁
		周圍溫度是否降至5°C以下呢？	周圍溫度過低時，可能會影響雪櫃內溫度過冷。請將溫度設定為「Cold」。
		是否放在冷氣出風口的前方？	請勿放在冷氣出風口前。加蓋或以保鮮膜包裹可以防止食品結凍。
雪櫃變熱	雪櫃的側面發熱從箱腳底下吹出暖風	——	為了讓冷卻裝置運作時，往外排出的熱氣造成發熱的狀態。剛安裝好後或是夏季，有可能達到50～60°C。安全及性能上沒有問題，但請勿以手觸摸。

遇到問題時 ~續前頁~

問題描述	請確認	請依照指示這樣做 / 理由
雪櫃發出嘈雜聲音	地板是否彎曲了？	請鋪上厚度 1cm 以上的牢固板子後，再將雪櫃安裝於板子上。 → 8 頁
	雪櫃是否靠著牆或家具？	雪櫃周圍請空出間隙再行安裝。
	雪櫃是否充分冷卻？	購買後、剛開始使用等雪櫃尚未完全冷卻時、雪櫃門開關頻繁及周圍的溫度較高時，由於壓縮機高速運作，可能感覺聲音較大。
	是否設定為「Quick」或是「Quick Cool」？	設定在「Quick」或「Quick Cool」時，壓縮機及風扇馬達會加速運轉，聲音會變大。
聲音不對	運轉聲長	因處於節能運轉狀態，壓縮機運轉較慢，因此運轉聲音可能持續較久。
	有時聲音變大	因應雪櫃內的溫度變化，變更運轉強度，也會感覺到較大的聲音。
其他 若聽到這種聲音時	像流水的聲音 (啾囉啾囉) 像碰撞的聲音 (叩吱叩吱) 像沸騰的聲音 (噉噉噉) 像燒烤的聲音 (唧—)	是雪櫃的雪種流動聲、除霜時的水流聲或是蒸發的聲音。當打開冷藏室門時，裡面也可能發出聲音。非異常狀況。
	像摩擦的聲音 (啤唏)	是雪櫃的溫度變化時，或真空冰溫室的氣壓變化時，零件的摩擦聲。非異常狀況。
	像什麼被卡著的聲音 (嗒嗒) 像低鳴的聲音 (撲—)	是雪櫃內控制溫度的電氣零件運轉聲音。非異常狀況。
	自動製冰機的聲音 (啾—) (嘎啦嘎啦) (咯噠咯噠)	是冰塊從自動製冰機的製冰盤掉落時，或是製冰盤裡給水時所發出的聲音。 非異常狀況。 當不需製冰時，按下 Ice Maker 按鍵，使其顯示為「Off」就不會發出聲音。 → 17 頁
	時常有的聲音 (卡嗒卡嗒) (機哩機哩)	為了冷卻雪櫃而開始或結束運轉的聲音。 非異常狀況。

問題描述	請依照指示這樣做 / 理由	
觸碰到雪櫃會感到微量的電流	雪櫃會帶有靜電，安全上則沒有問題。	
電視機、收音機等發生雜音、映像的混亂	是由於受到從雪櫃發出的微弱電磁波的影響。 安裝時請遠離電視機、收音機、門鈴對講機等。 建議在離開天線等的地方接電源。	
塑膠零件上有像刮痕一樣的細線	是塑膠成型時發生的樹脂流痕。透明的部件會特別顯眼，但強度上沒有問題，不會破裂。	
雪櫃門面或側面、頂部有波紋或歪扭	雪櫃的製造工程上，會產生些微的波紋或歪扭。 根據光線照射方向及亮度等會顯得刺眼，非異常狀況。 另外在性能上也沒有問題。	
雪櫃門內側或冷藏室側面有小的洞	<p>雪櫃製造過程中，當填充斷熱材料時為了讓內部的空氣往外散出所製成的洞。非損傷也非異常情況。</p>  <p>※ 依商品不同，可能會貼有貼紙，使用時請勿將貼紙撕下。</p>	
停電了	到恢復供電之前，請減少雪櫃門的開關，也避免放入新的食品。 恢復供電後，請確認操作面板的設定。	
長時間未使用雪櫃	請將雪櫃內的東西全部清出。 請先將電源插頭拔除，再進行雪櫃內自動製冰機的清潔。 請打開所有的雪櫃門使其乾燥2~3天。 → 25~27頁	
除霜	此雪櫃會自動除霜，不需要特別操作。溶解的水會滴在蒸發盤上，自動蒸發。	
移動、搬運	請參閱「移動、搬運的事前準備(搬家時)」。 → 36頁	
玻璃破裂(雪櫃門玻璃、玻璃層架)	請勿觸碰破碎的玻璃，並立刻聯絡購買的經銷商委託修理。	
關閉雪櫃門時，其他雪櫃門自動開啟	是否因關雪櫃門時用力過猛呢？ 由於各冷藏室的冷氣通路是相通的，可能因為關閉雪櫃門時的風壓而導致其他雪櫃門瞬間開啟。	
雪櫃門關上後想再打開時，感覺很重	雪櫃門是否長時間處在開啟狀態呢？ 由於雪櫃內空氣瞬間被冷卻，短時間內壓力變低所造成的狀況。 請勿長時間打開雪櫃門，並盡量縮短開關的時間。	
特別在意震動音，因濕氣而導致背面牆壁變色、髒污時	請將雪櫃安裝在距離背面牆壁(2cm以上)較遠的地方。 → 8頁	
小蒼蠅等昆蟲飛入雪櫃時	周圍是否有蒼蠅？	敬請保持周邊環境乾淨。 請放置蒼蠅忌避物品或補蠅器。
	雪櫃內是否存放氣味強烈的食品？	為了避免氣味吸引蒼蠅，請將食品加蓋或以保鮮膜包覆。
	雪櫃門是否長時間開啟？	請盡量在拿取食品後馬上關上雪櫃門。

其他

遇到問題時

遇到問題時 ~續前頁~

移動、搬運的事前準備 (搬家時)

1 將食物及冰塊取出。

2 將儲水箱、製冰盤的水倒掉。

拆下儲水箱並進行製冰機清潔。

→ 27頁

3 拔除電源插頭。

要搬動之前拔除即可。

4 拆除腳座護蓋，將調節腳升高。

→ 8頁

5 以膠布將雪櫃門、電源線固定。

6 移動、搬運時請鋪上保護用的鋪墊或布。

防止刮花地板、或雪櫃內部積水溢流至地板。

7 在地板上鋪上鋪墊或布，
將雪櫃往後傾倒，
讓內部的水倒出。



8 搬運時請握住搬運把手搬運，
並請2人以上進行搬運。

運輸時請勿將雪櫃橫放。
(雪櫃故障的原因)

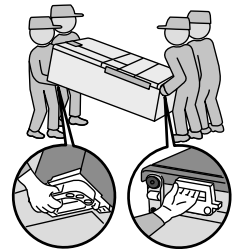

9 在預定放置的位置，請依照「使用前的準備」
的指示進行設置。 → 8、9頁

另購零件

■ 以下零件更換時，請務必向經銷店指明雪櫃的型號，購買專用的零件。

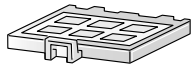
另購零件時	商品名	型號	商品型號
冰塊有味道時 可能淨水濾片老舊、髒污。 (約3~4年更換一次)	自動製冰用淨水濾片	全機種通用	RJK-30 

—MEMO—

遇到問題時 / 另購零件

—MEMO—

A series of horizontal dashed lines for writing.

CONTENTS

BEFORE USE

SAFETY SUGGESTIONS	40
BEFORE USE	44
NAME & FUNCTION OF EACH PART ..	46
Functions of the Control Panel/Name of each compartment ..	46
Display Section	46
Food Storage Recommendations	47

HOW TO USE

REFRIGERATOR COMPARTMENT	48
Name of each part	48
Adjusting the Temperature (Refrigerator) ..	48
Using "Moisture Cooling"	48
To chill food quickly (Using "Quick Cooling")	49
Opening and closing the doors	49
Adjusting the height of pockets and shelves ..	49
EXTRA FRESH ROOM	50
Storing food	50
Opening and closing the Extra Fresh Case ..	51
ICE COMPARTMENT (AUTOMATIC ICE MAKER) ..	52
Making ice	52
Ice storage capacity and time required to make ice ..	53
Quick Ice Making	53
Stop Ice Making	53
Water supply indicator	53
Ice Maker "On" or Freezer "Coldest/Cold" and Fridge "Cold" are blinking	53
FREEZER COMPARTMENT	54
Storing food	54
When freezing meat, fish, or rice (Using "Delicious Freezing")	55
Adjusting the Temperature (Freezer)	55
VEGETABLE COMPARTMENT	56
Storing food	56
Adjusting the Temperature of the Vegetable Compartment (Using "Powerful" mode in "Veg") ..	57
Tips for storing vegetables	57
VARIOUS FUNCTIONS	58
Further temperature adjustments (Refrigerator/Freezer) ..	58
"eco" operation indicator lamp	58
Door alarm	59
Volume adjustment of door alarm and operation sound ..	59
Triple power deodorizing effect (Refrigerator) ..	59
SAVING ENERGY	60
"Energy Saving" mode	60

MAINTENANCE

MAINTENANCE	61
Power plug / Door gasket	61
Door surfaces / Shelves and Pockets / Liquid receiver ..	61
Refrigerator back/sides/bottom / Cases	61
Extra Fresh Room	62
Water Supply Tank	62
Ice maker cleaning	63
HOW TO REMOVE/ATTACH PARTS ..	64
Height adjustable upper and middle shelf ..	64
Height adjustable lower shelf	64
Fixed shelf	64
Shelf partition	64
Door pockets	64
Extra Fresh Case	64
Ice Case (Ice Compartment) and Upper Freezer case (Upper Freezer) ..	65
Slide Case and Lower freezer case (Lower Freezer) ..	65
Upper Case and Lower Case (Vegetable Compartment) ..	65
How to remove/Attach the slide door	65

TROUBLESHOOTING and AFTER-SALES SERVICE

TROUBLESHOOTING	66
Initial stage	66
Refrigerator is not cold	66
Frost or condensation formed	66
Automatic ice making	67
Indicator is blinking	68
Concerns on the Vegetable Compartment ..	68
Concerns on the Extra Fresh Room	69
Concerns on uneven height or tilting of the doors ..	69
Strange smell	69
Refrigerator is too cold	69
Refrigerator becomes hot	69
Concerns on noises	70
Others	71
Preparation for moving/transporting (moving house) ..	72
AVAILABLE PARTS	72
NOTES ON NON-CFC REFRIGERATORS/ GUIDE ON TOTAL STORABLE WEIGHT	75
AFTER-SALES SERVICE	76





SAFETY SUGGESTIONS

Please ensure to follow these precautions

When using this appliance, failure to follow safety precautions may result in personal harm, harm to other people, and also damage to property.

■ The following notes are categorized and explained by the following symbols according to the hazard level in terms of harm and material damage that may occur from ignoring suggestions and not using correctly.

■ Suggestions are indicated and categorized by the following symbols accompanied by explanations. (The symbols below are examples)





 WARNING	Suggestions headed by this pictograph indicate "There is high chance of serious injury or death" if ignored.	 This symbol indicates "Warning and calling attention".
 CAUTION	Suggestions headed by this pictograph indicate "There is a high chance of injury or damage to property" if ignored.	 This symbol indicates something you must not do. (Prohibited)
		 This symbol indicates something you must do. (Compulsory)

■ This refrigerator uses flammable refrigerants. The symbol column below states the precautions on flammable refrigerants.

 This symbol denotes the precautions on flammable refrigerants.
R600a

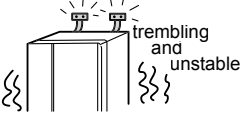
! WARNING

Installation



- 
Take measures to prevent overturning of refrigerator due to earthquake, etc.
 - Overturning of the refrigerator could result in personal injury.
- 
Do not install the refrigerator in damp places or where water may adhere to.
 - This may impair electricity insulation causing electric shock or fire.
- 
Do not locate multiple portable socket-outlets or portable power supplies at the rear of the appliance.

Handling the power and power cable

- 
Avoid usage that may cause the wall outlet or power cord components to work beyond their specified electric current.

Also do not use power sources that are not a rated AC voltage.

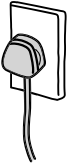

If a power source is shared with other appliances, double or multipoint adapters may heat up beyond normal levels and cause fire.

 - Use a wall outlet rated above 10 ampere by itself.
- 
When positioning the appliance, ensure the supply cord is not trapped or damaged.

(The power cord or plug should not be cut, modified, touched with hot implements, bent by force, twisted, pulled, have heavy objects placed on it, pressed by the refrigerator, or be bound or tied up.)

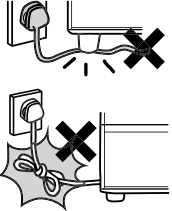
Using a damaged power cord may cause electric shock, short circuits, or fire.

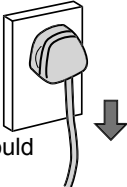
 - If the supply cord is damaged, it must be replaced by the manufacturer or its service agent or a similarly qualified person in order to avoid a hazard.

- 
Connect the power plug firmly to a power outlet with the cord downwards.
 - Connection of the power plug with the cord running upwards could apply stress on the cord and cause electrical short circuit or overheat, resulting in electrical shock or fire.
 - Incomplete connection of the power plug could result in electrical shock or fire due to heat.
- 
Clean the dust on the power plug frequently.

Insulation failure from moisture from the dust collected on the power plug may cause fire.

 - Unplug the power plug and wipe it with a dry cloth.

⚠ WARNING

Handling the power and power cable



Wet Hands Prohibited

- **Do not insert or remove the power plug with wet hands.**
 - This may result in electric shock.



- **Be sure to unplug the power plug before doing maintenance to the refrigerator.**

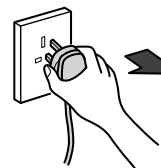

Continued use may cause electric shock or injury. → Pg.61

- Always hold the plug when unplugging it.

During use



Wetting Prohibited

- **Do not splash water on or inside the refrigerator.**
 - This may impair electrical insulation causing electric shock or fire.

- **Do not put water containers on top of the refrigerator.**
 - Spilled water may impair insulation of electrical components causing faulty electrical currents. This may result in electric shock or fire.



Prohibited

- **Do not put in items that may catch fire**
 - Benzene, ether, LP gas, thinner, adhesives may ignite an explosion.

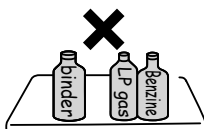

- **Drugs, chemicals, research and experimental substances should not be stored in the refrigerator.**
 - Substances that require precise conditions for storage cannot be stored in a domestic refrigerator.



- **Do not store dry ices in the refrigerator.**
 - It might explode if sealed.

- **Do not use flammable sprays near the refrigerator.**
 - Sparks from points of electrical contact such as door switches may ignite a fire.

- **Do not put things on top of the refrigerator.**
 - Opening and closing doors etc. may cause things placed on top of the refrigerator to fall resulting in injury.

- **Do not hang on the doors or step on the various compartments.**
 - Injury may be caused by the refrigerator tipping over or hands getting caught between doors.

- **Do not remove the cover of the interior lamp.**
 - When the interior lamp is damaged, please contact the service centre to replace it so as to avoid injury.

- **Do not put too much force on the door by opening it too much or leaning on the opened door.**

- **Do not add impact to the glass door.**



Contact Prohibited

- **Do not touch the machinery components of the automatic ice maker.**



- There is a danger of injury when the ice trays are rotating.



- **This appliance is not intended for use by persons (including children) with reduced physical, sensory or mental capabilities, or lack of experience and knowledge, unless they have been given supervision or instruction concerning use of the appliance by a person responsible for their safety. Children should be supervised to ensure that they do not play with the appliance.**

SAFETY SUGGESTIONS (Continued)



About the refrigerant (Be careful of the following related to the use of flammable gas.)



Prohibited

- Do not scratch or damage the main body of the refrigerator with a sharp object such as screw.

Since the refrigerant used is flammable, any leakage from the pipe inside the wall may cause ignition and explosion.

- Do not use mechanical devices or other means to accelerate the defrosting process, other than those recommended by the manufacturer.

- Do not use electrical appliances inside the refrigerator.

- If the refrigerant leaks, sparks on the contact may cause ignition and explosion.



- Do not damage the refrigerant circuit. If you happen to damage the

refrigerant pipe, stay away from the refrigerator and avoid using fire and electrical appliances.

Should you damage the refrigerator, open the window to ventilate and contact the authorised service centre.

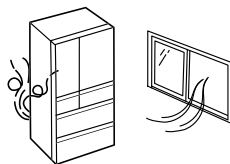

- Keep ventilation openings, in the appliance enclosure or in the built-in structure, clear of obstruction. → Pg.44

Leakage of the refrigerant may accumulate and cause ignition and explosion.

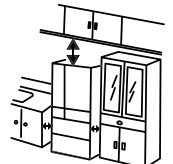

- Please consult your dealer or the Recycle Hotline of the Recycle Centers in the Environmental Protection Administration when discarding the unit.

If the refrigerant leaks, it may cause ignition and explosion.



R600a

- The warning label and name plate including this symbol affixed on compressor and refrigerator should be kept throughout the life of the refrigerator.

- Handling, service, disposal and installation of used flammable refrigerant shall be done by Hitachi authorized service companies or service engineer only.

In case of emergency



- Stop the refrigerator by unplugging it if it is not running properly or breaks down.

Continuous running may cause electric shock or injury.

- Always hold the plug when unplugging it.

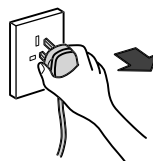

Disassembly prohibited

- Do not disassemble, repair, or modify your refrigerator.

Injury may be caused by ignition of fire or faulty running.

- Please consult with a retailer if any repairs or disassembly are required.



- In the event of gas leak, do not touch the refrigerator and open windows to allow ventilation.

- Sparks from points of electrical contact such as door switches may ignite explosions causing fire or burn injuries.



When discarding the unit



- Before discarding the unit or recycling, remove the door gaskets to avoid the risk of an infant or child being entrapped inside.

CAUTION

When moving the refrigerator



Prohibited

- Do not move the refrigerator by using its wheels as it may damage the floor.

- Please lay a protective mat.

- Never hang the handle with a crane, etc.

- Be careful not to knock the back/sides of the refrigerator.

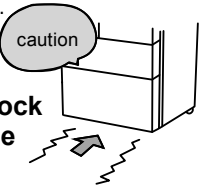

- Use the carrying handle when carrying it. Your hands may slip resulting in injury if you hold the refrigerator at other places other than the carrying handles.

- More than 2 persons should carry the refrigerator for safety reasons.

- Carry it with the door facing upward; as shown in the illustration.

- Use a tape to fix an electric plug/power cord so that it will not hang down.



During use



Prohibited

- Do not put bottles in the Door Baskets if they do not sit properly on the bottom of the front section.

- Forcing in items like large bottles may result in them getting tipped over, causing injury.



- Do not put the glass bottles in the Freezer Compartment.

- Bottles may break from the contents freezing and cause injury.

- When opening or closing a door while the adjacent door is left open, exercise caution lest your hand or a finger should be caught between the opened doors.

- Do not close a door with other than the handle.

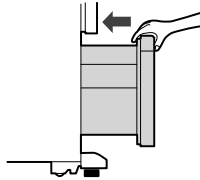

- Do not put your feet too close when opening the bottom door of the refrigerator.

- You may hit the instep or other parts of your feet resulting in injury.

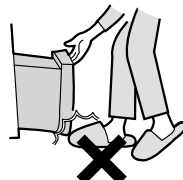

- Do not put your hands or feet under the base surface of the refrigerator.

- When cleaning, putting your hands under the base surface of the refrigerator may result in injury by cutting them on sheet metal parts.

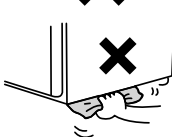

- Do not give a hard impact to the glass shelf. (The glass shelf may be broken, causing personal injury).

- Do not have food items protruding over the front of the shelves.

- Injury may be caused from items like bottles getting knocked over.

- Do not open or close the door with force. (Doing so may cause food to drop)

- Do not open or close a door while other person is using the refrigerator.

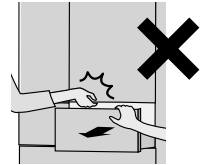

- Do not open or close a door of the Refrigerator Compartment while holding the handle of the drawer.

- Do not touch the food and containers inside the Freezer Compartment with wet hands.

- This may cause frost injury. (Especially in the case of metal items)

- Do not eat food that smells strange or has changed color.

- Spoiled food may cause serious sickness.

- Neither heat the glass surface of the glass shelf nor put a hot item on it.



- To prevent water from dripping on the floor. Water due to dew and/or frost may drip on the floor if there is a gap clearance around the door for a long time. Close the door completely without no gap.

- When opening and closing a door while other door is opened, be careful lest your finger or hand should be caught between the opened doors.

- Take care when removing the glass shelf because it is heavy.

- When you hear an abnormal sound or find abrasion powder during the opening or closing of a door, stop using the refrigerator and call for inspection.

BEFORE USE

1

Preparation before use.

- The floor should be sturdy and flat.
Lay a board with 1cm thickness on the floor if the refrigerator is installed on the carpet, tatami mat, flooring or PVC sheet flooring which may be hollow or discolor.
- Place the refrigerator away from direct sunlight and heat.
This will reduce adverse effects to refrigerating power and keep electricity cost down.
- Do not place it in damp areas, and ensure good air ventilation.
This will prevent rust and condensation.
- The refrigerator should be separated from other equipment such as TVs.
This is to prevent disturbance (noise / scattered image) to TVs and other devices caused by the refrigerator.

- ※ The actual size of the center part of the side of the refrigerator's main body is slightly larger than the nominal size. Therefore, please allow sufficient space around the refrigerator when installing it.
- ※ If you are concerned about noise caused by vibration or condensation on the rear of the refrigerator or discoloration/markings on the wall due to high humidity, install the refrigerator with a gap of **2 cm or more**.

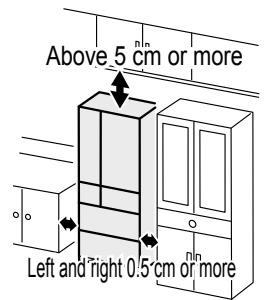

2

Adjust and fix the refrigerator horizontally.

- 1 Hold the leg cover and pull it toward you to remove it.

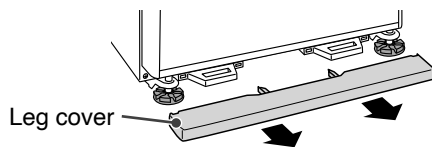

- 2 Place cushions under the adjustable mounts.

Place the cushions under the adjustable mounts evenly at the front, back, left and right.

- Always wipe the adjustable mounts and clean the floor before placing the cushions. Any dirt under the cushions may scratch the floor.

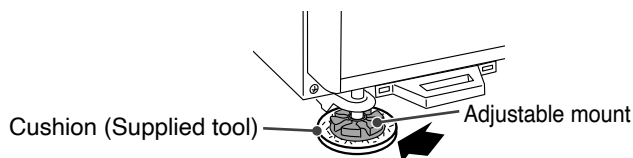

- 3 Turn the left and right adjustable mounts until they touch the floor. Adjust so that the left and right doors of the refrigerator compartment are parallel.

As a guide, the height of the door can be adjusted 1mm every one turn of the adjustable mount. If the adjustable leg is difficult to turn, insert a Phillips screwdriver to turn it.

■ The left side door is lower

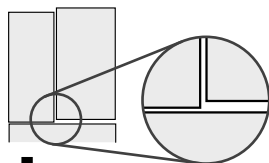

Turn the left adjustable mount clockwise to level the left and right doors.

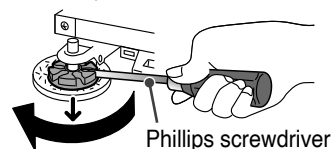

■ The right side door is lower

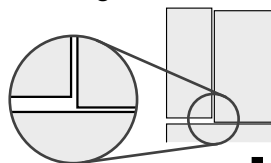

Turn the right adjustable mount clockwise to level the left and right doors.

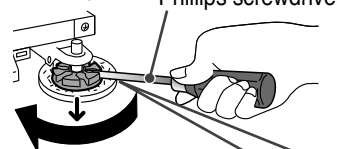

- Be careful not to scratch the floor with the Phillips screwdriver when turning the adjustable mount.
- Excessively turning an adjustable mount may cause it to detach.

- 4 Insert the fork of the leg cover into the mounting holes to attach the cover.

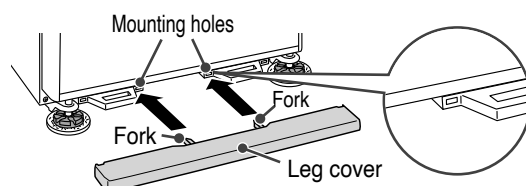

Use the supplied cushion [2 pc]

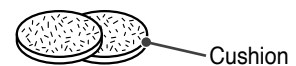

Note

- Packaging specifications may vary depends on production time, but this does not affect the quality.
- Depending on the strength and type of the floor material, and the weight of the food, the door may lower several days later (about 5 days). In this case, adjust the doors to be parallel again.
- If the place where the refrigerator is installed is not horizontal or the floor material is soft, there may be a height difference between the left and right doors of the refrigerator. There is no problem with the functioning of the refrigerator, but if you are concerned, adjust the doors to be paralleled by following the above described procedure.
- If you make the refrigerator horizontal left to right but make the front slightly higher than the back, it will be easier to close the doors and the doors will be less likely to remain partially open.
- When you release your hand from a refrigerator door with the door open, the door may move. But this is normal.

Recommended size of Phillips screwdriver

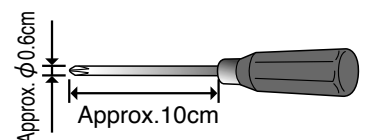

Insert the Phillips screwdriver securely into the groove of the adjustable mount and then turn it.

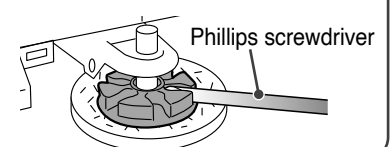

3

Cleaning the inside of the refrigerator. → Pg.61–63

- Wipe with a soft, damp cloth, then finish with a dry cloth.
- Rinse the Water Supply Tank and water filter.
- ※ Do not wipe off the lubricant applied to the slide door rails or the contact surface of the rails.
- ※ At the beginning, the refrigerator may smell of plastic.
If you are concerned, ensure that the room is well ventilated.
(Smell will gradually disappear)

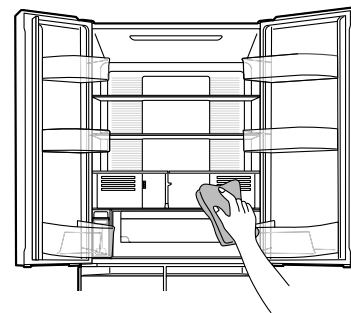

4

Plug the power cord.

You may plug in the power cord immediately after installing the refrigerator.

Do not share the wall outlet with any other appliances. (Alternating current 220–240 V, rated 10 A or more)

- Check that the power plug or the cord is not wedged between the back of the refrigerator and the wall in order to prevent the cord from getting hot.

Cooling inside the refrigerator begins (after cooling the refrigerator compartment, the other storage compartments are cooled (ice compartment, freezer compartment, vegetable compartment))

It may take more than 4 hours to cool well the inside of the refrigerator, depending on conditions such as the ambient temperature or storage state of foods.

It may take 24 hours or more in summer, etc.

Do not put ice cream, uncooled foods or perishable foods in the refrigerator until the inside has cooled well.

Perform **"Ice Maker Cleaning"** when using the automatic ice making function for the first time. → Pg.63

Ice making will start automatically after the inside of the refrigerator has cooled well.

(When using for the first time, **it may take 24 hours or more to make ice.**)

When the temperature inside the refrigerator is low, cooling may not start for about 10 minutes after plugging in the power plug.

Note

- **Rust proofing of the piping may be required.**

When installing the refrigerator near a hot spring area, industrial area, or near sewer pipes, etc., the piping may corrode due to the effect of sulfide gas. Contact your dealer. The warranty does not cover failures due to sulfide gas damage, such as blackening of the piping.

- **After inserting the power plug into a wall outlet, you will hear noise from the refrigerator. It is preparing for operation.**

You may also hear a louder noise from the compressor or fan until the inside is cooled enough.

- Do not peel off the sticker on the back or remove the plastic parts on the sides of the refrigerator at the bottom.
- If you attach a magnet or suction cup to the front of the main body or to a door, it may leave a mark.
- If you attach paper to the door surface in a high ambient temperature environment, condensation may form on the door surface or the paper may absorb moisture.

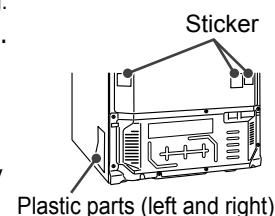

NAME & FUNCTION OF EACH PART

Functions of the Control Panel

Name of each compartment

Ice Maker

- Quick → Pg.53
- On → Pg.52
- Off → Pg.53

Cooling mode

- Moist Cool → Pg.48
- Veg → Pg.57
- Quick Cool → Pg.49

Energy Saving

Slightly reduces the cooling in each compartment to save energy.

- Save → Pg.60

Request

Do not apply strong force to the operation panel or strike it with hard objects.

Note

- When the lamp on the Control Panel blinks → Pg.68

Freezer/Fridge

The temperature of the freezer and refrigerator can be adjusted to three levels.

- Adjust the Temperature → Pg.48, 55

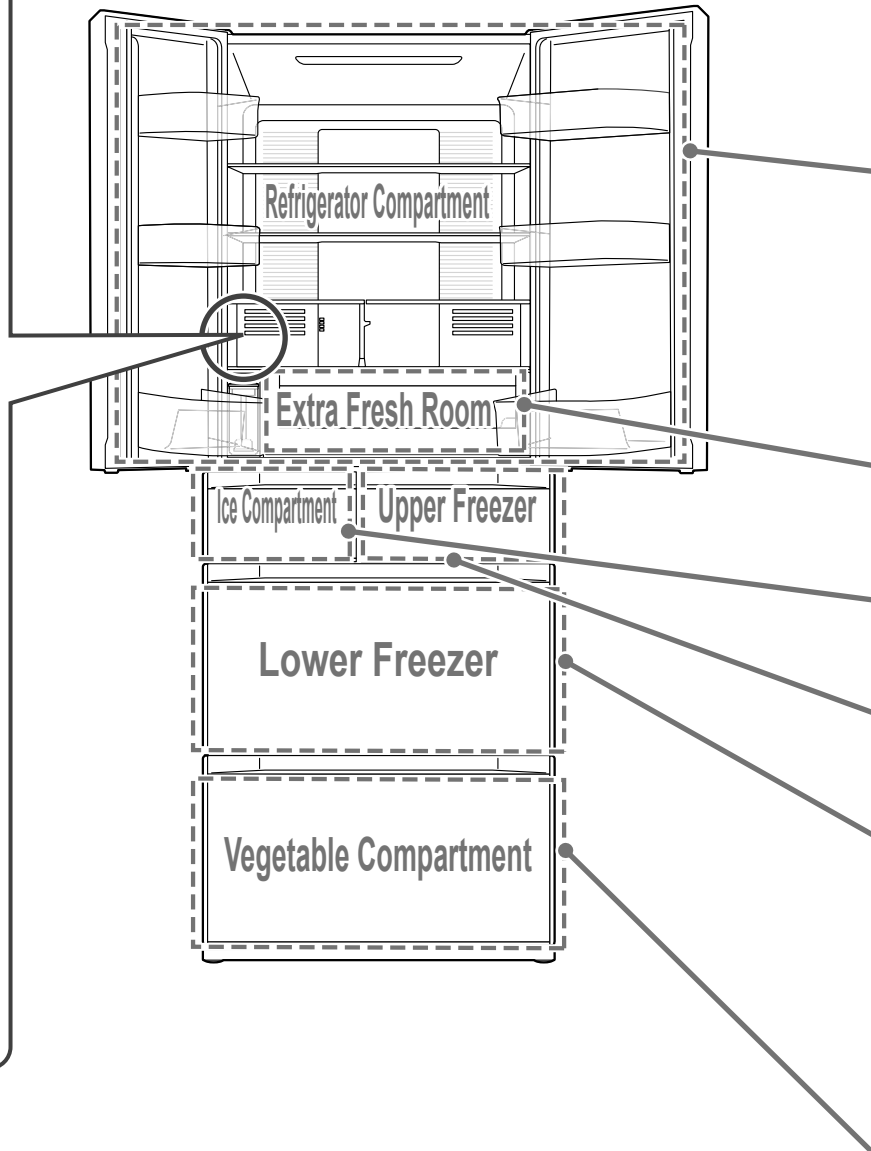

Display Section

Display Section

- "eco" operation indicator lamp → Pg.58
- Water supply indicator → Pg.53

Food Storage Recommendations

Storage location		Estimated temperature	Food
Refrigerator Compartment → Pg.48	Shelf	About 2°C to 6°C	Foods used daily
	Door pocket	About 2°C to 9°C	
Extra Fresh Room → Pg.50		About -2°C to 0°C	Fresh food such as meat and seafood
Ice Compartment → Pg.52		About -19°C to -17°C	Ice made by automatic ice making
Upper Freezer → Pg.54		About -19°C to -17°C	
Lower Freezer → Pg.54		About -20°C to -18°C	
Vegetable Compartment → Pg.56	Upper/lower space	About 4°C to 8°C	Upper space Small vegetables, partially used vegetables, fruit, etc. Lower space Leafy vegetables (spinach, Komatsuna (Brassica rapa), etc.), Large vegetables (cabbage, lettuce, etc.)
	Vertical storage space	About 4°C to 9°C	Vertical storage space Long vegetables, plastic bottles, etc.

※ The temperatures assume an ambient temperature of approx. 32°C around the refrigerator, the refrigerator and freezer compartments set to "Normal", no food inside, the doors closed, and a stable temperature.

※ The temperature may vary depending on food storage conditions, door opening and closing, etc.

- Tips for storage**
- Allow some spacing between foods when storing it.
 - It is recommend to wrap foods with strong odors in cellophane wrap.
 - Refer to guideline on food weight storage. → Pg.75

REFRIGERATOR COMPARTMENT

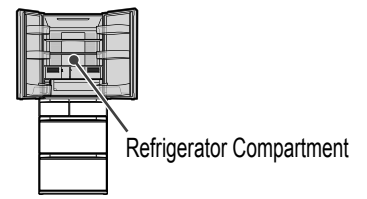

Name of each part

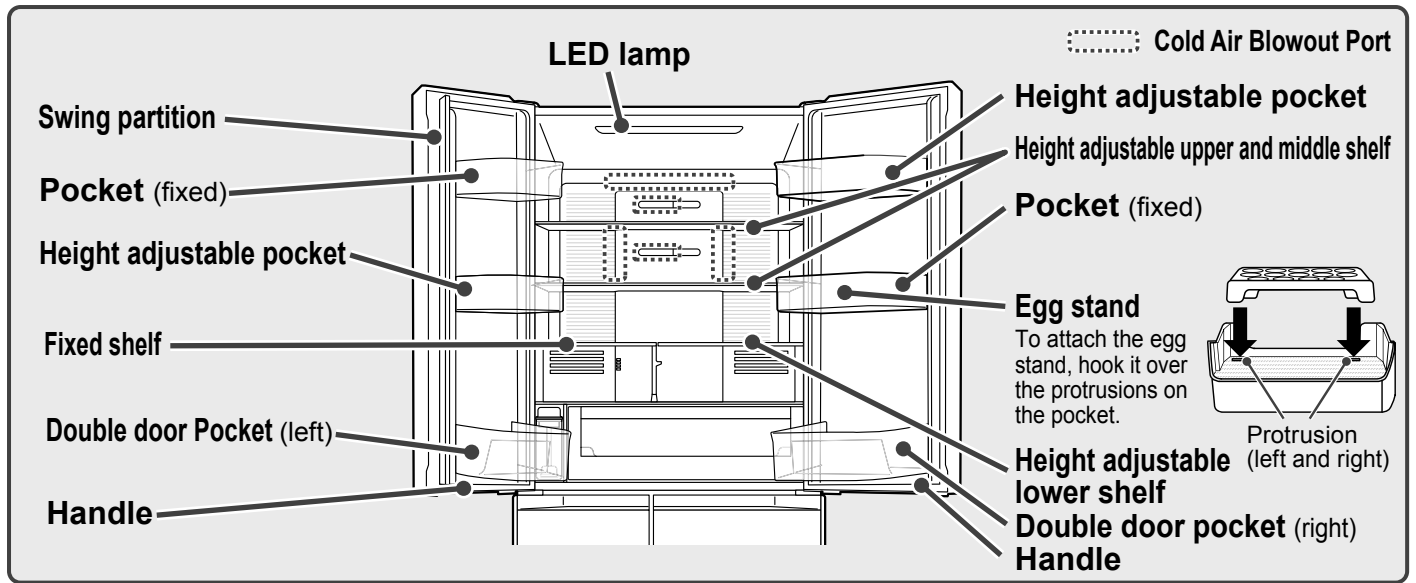

Request

- Do not place foods with high water content/canned beverages around a Cold Air Blowout Port because they may freeze or explode. They are especially likely to freeze in "Coldest" or "Moist Cool" mode. You can prevent food from freezing by using a lid or cellophane wrap.
- When storing dry food such as rice or seaweed, put it in a closed container (bag) before storing. Otherwise, dried food may absorb moisture.

Adjusting the Temperature (Refrigerator)

You can change the temperature by pressing Fridge.

The default setting is "Normal".

Select "Coldest" if you need additional cooling, such as in the summer.

Request

If the refrigerator is too cold, use "Normal" or "Cold".

Note

- The temperature of the refrigerator will vary slightly depending on the operating conditions.
- More temperature adjustments is available. → Pg.58
- When set to "Moist Cool," the display for the Refrigerator Compartment temperature setting turns off.

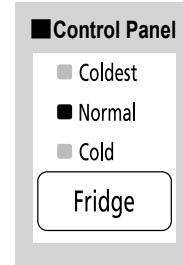

Guide for refrigerator compartment temperature
 "Coldest" is about 1 to 3°C lower than "Normal"
 "Cold" is about 1 to 3°C higher than "Normal"

Using "Moisture Cooling"

- "Moisture Cooling" will be activated in the entire refrigerator compartment. (When set: about 0 to 3°C)

It is recommended for storing prepared side dishes.

When storing warm food, cool it to a temperature of 50°C or lower.

before putting it in the refrigerator. This will prevent burns and deformation of the shelves.

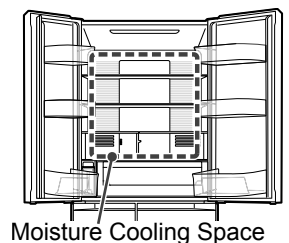

To activate "Moisture Cooling"

The default setting is "Off".

Press and hold Powerful for 3 seconds or longer until there is a long beeping sound and "Moist Cool" lights up.

Fridge temperature setting is deactivated.

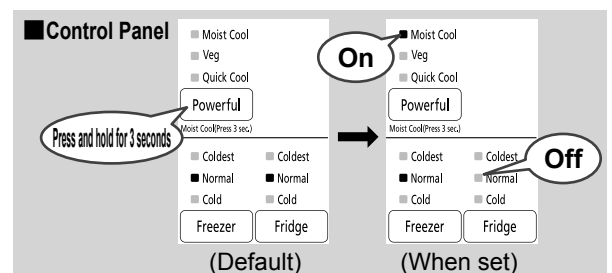

To cancel "Moisture Cooling"

Press and hold Powerful for 3 seconds or longer until the setting is released (two short beeps), to deactivate "Moist Cool".

To chill food quickly (Using "Quick Cooling")

When you want to cool food quickly, you can increase the cooling of the "Moisture Cooling Space".

You can reduce the time required to cool warm food and remove excess heat after cooking. This feature is recommended when you want to quickly cool packed lunches, drinks, or cooked vegetables, etc. before going out. When storing warm food, cool it to a temperature at which you can touch it (about 50°C or less) before putting it in the refrigerator. This will prevent burns and deformation of the shelves.

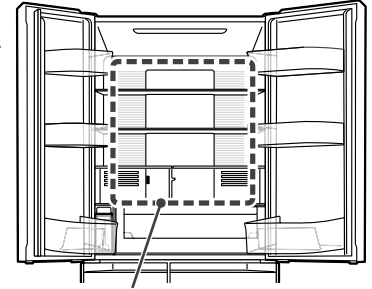

Moisture Cooling Space

Note

- Power consumption is higher when "Quick Cool" is activated.
- Continuous use of "Quick Cool" may freeze the food in the refrigerator.
- "Quick Cool" can be used even when "Moist Cool" is activate.

To activate "Quick Cooling"

The default setting is "Off".

Press **Powerful** to activate "Quick Cool".

"Quick Cool" stops automatically after about 60 minutes and the "Quick Cool" display turns off. Depending on the temperature of the refrigerator, it may operate for 60 minutes or more.

To cancel "Quick Cooling"

Press **Powerful** to deactivate "Quick Cool".

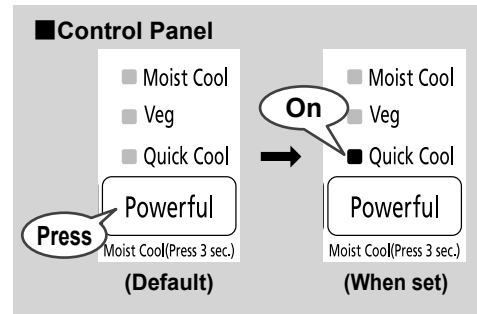

Opening and closing the doors

Note

Do not apply excessive force by opening the door too strongly or leaning against the open door. The door may break.

Use the handles to open and close the doors.

To open the door

Do not open the door by holding the swing partition. (The door cannot be opened)

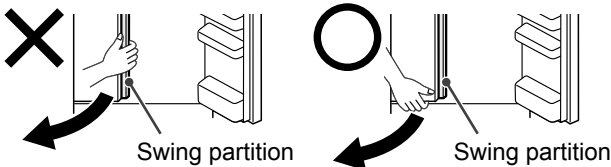

To close the door

Do not close the door with the swing partition opened. (The door will not close completely)

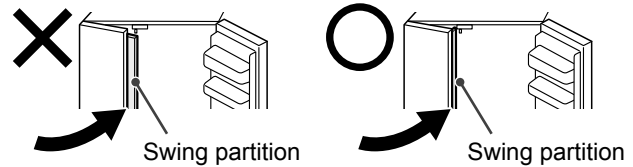

Adjusting the height of pockets and shelves

You can change the positions of pockets and shelves according to the sizes of the food and beverages you wish to store. How to remove/attach → Pg.64



Handling the glass shelves

- Do not apply force to the glass shelves. (It may break and cause injury)
- The glass shelves are heavy. Handle with care when removing/attaching them.

Height adjustable upper shelves, height adjustable middle shelves, height adjustable lower shelves, height adjustable pockets

Can be adjusted according to the height of the food or beverage.

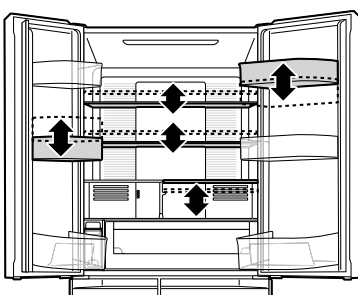

Default

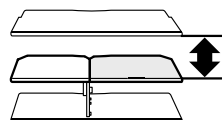

Set the shelf to the uppermost position

Storage of pans, etc.

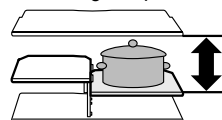

Set the shelf to the middle position

Storage of milk cartons, etc.

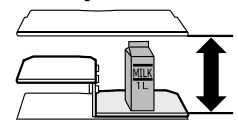

Set the shelf to the bottom position

EXTRA FRESH ROOM

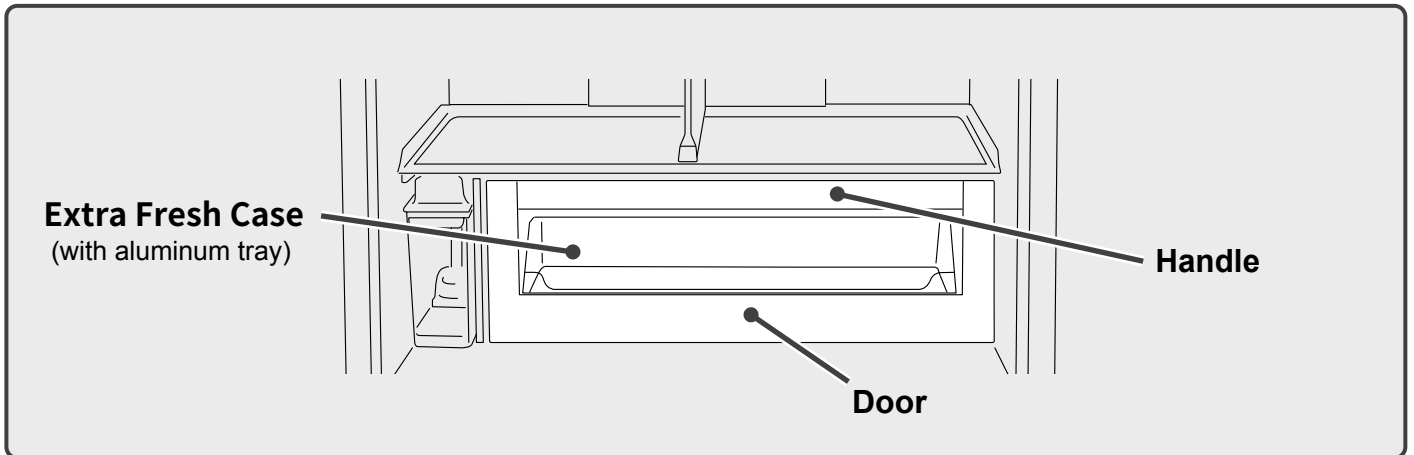
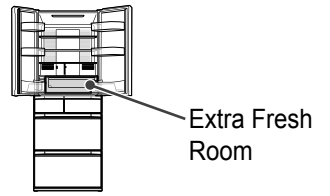

Storing food

Extra Fresh Room (About -2°C to 0°C)	<ul style="list-style-type: none"> ● Meat and processed meat products ● Fish, seafood, and processed seafood products ● Thawing meat and fish
<ul style="list-style-type: none"> • Foods with high water content may freeze. 	

Caution

- Foods with high water content may freeze when the ambient temperature is low.
- Changing the Refrigerator Compartment or Freezer Compartment temperature setting also changes the Extra Fresh Room temperature.
- **Do not overfill the Extra Fresh Room with food or containers.**
It may be difficult to pull out the Extra Fresh Case.

■ Foods not suitable for the Extra Fresh Room

The following foods are not suitable for this compartment. Store those foods in the refrigerator compartment.

- Dairy products
- Cut vegetables and fruits
- Foods for which small bubbles appear when frozen



Opening and closing the Extra Fresh Case

When opening

Hold the handle and pull the Extra Fresh Case forward.

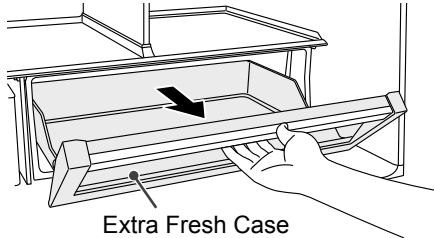

※ If you try to pull the Extra Fresh Case forward without opening both the left and right doors of the Refrigerator Compartment, parts may break.

When closing

Push the Extra Fresh Case all the way in.

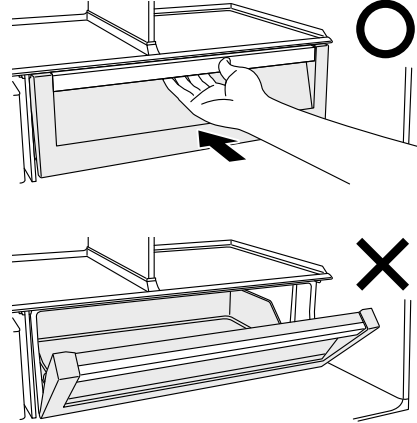

※ Push it all the way in before you close the refrigerator door.

Caution

● If you close the refrigerator door without pushing the Extra Fresh Case all the way in, parts of the refrigerator or food may be damaged. The door may not close fully, resulting in poor cooling.

Note

- Water contained in food or air may cause water drops, frost, or ice to form inside the compartment. Wipe off with a soft cloth moistened with warm water. (The performance will not be affected even if there are water drops, frost, or ice in the Extra Fresh Room.)
- If you are concerned about water drops, frost, or ice, it is recommend to wrap stored food in cellophane wrap.
- If you spill water or juice from food in the compartment, wipe it off immediately.
- If food packaging is stuck, remove it.

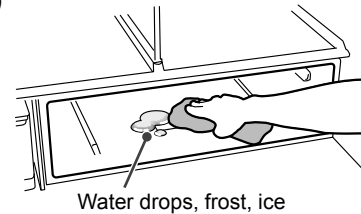

Water drops, frost, ice

● Do not put heavy objects on the door while the Extra Fresh Case is open.

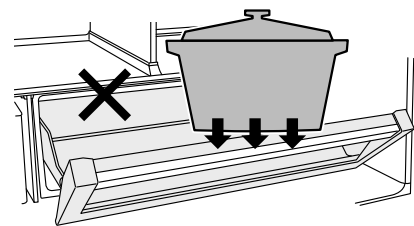

● There is a protective film on the transparent part of the door surface. Leaving this protective film in place will not affect the performance of the refrigerator, but if you prefer, please remove it before use.

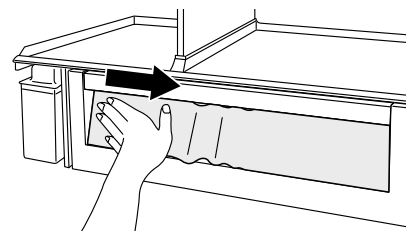

To remove the protective film, pull the film from the edge to the center as shown in the picture.

ICE COMPARTMENT (AUTOMATIC ICE MAKER)

Ice Compartment

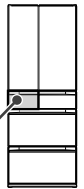

Water Supply Tank
(capacity about 1.0 L)

Control Panel

Ice Case

Ice Compartment

Making ice

Perform "Ice Maker Cleaning" when making ice for the first time or for the first time in a week or more. → Pg.63

- 1 Press Ice Maker to activate "On" indicator.**

The default setting is "On".
- 2 Pull the water supply tank out horizontally.**

※ The water supply tank may feel heavy when you lift and pull it toward you.
- 3 Open the lid and add water.**

※ Do not fill above the "Container full line".
- 4 Replace the Water Supply Tank.**

Firmly push it all the way in

Firmly push it all the way in so that it passes the "Container set position" line.

If the Water Supply Tank is not pushed all the way in, it cannot make ice.

※ Water may spill out if the Water Supply Tank is tilted. Wipe off any spilled water immediately.
- 5 Ice making starts automatically.**

 - When the ice reaches the Ice full line of the ice case, the automatic ice making function temporarily stops. When the ice level becomes low, it will restart automatically.
 - When there is no ice in the ice case, a loud sound of ice falling from the ice tray may be heard.

Request

- **WARNING:** fill with potable water only.
- Water for ice making is according to your drinking standard. Quality of tap water may vary in different countries. Please check and verify with your local authority.
- Change water and clean the container at least once a week for hygiene purposes. → Pg.62
- If the ice made of mineral water containing a lot of mineral ingredients is put into water, white powder may appear, this is due to mineral ingredients and is harmless.
- These types of water are easily contaminated with bacteria. Please wash the container once every 3 days.

Mineral water
(Hardness: 100mg/L or less)

Filtered water or
boiled water

Well water
(Required to satisfy the appropriate
water quality standard)

- Do not use the following beverages as they may cause malfunction, deformation or sticking ice.

Juice drink

Sports drink

Carbonated drink

Tea

Ice storage capacity and time required to make ice

Model		R-HV490R Type
Ice storage capacity	When the ice is leveled	Estimated 140 ice cubes
Time for one cycle of ice making (12 ice cubes)	Normal "Ice making"	Estimated 110 to 140 minutes
	"Quick Ice Making"	Estimated 80 minutes

※ Approximate time when the ambient temperature is about 30°C, the Freezer Compartment temperature is set to "Normal", the Refrigerator Compartment temperature is set to "Moist Cool", and the door is not opened/closed.

Note

- Ice build-up in one place can stop ice making even when the ice level is low.

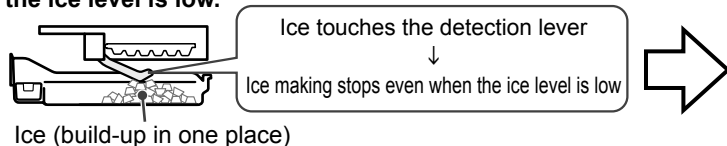

- To make more ice, move the ice to the front and level it off.

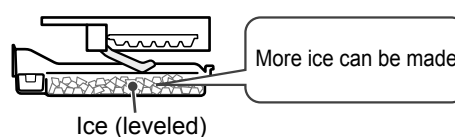

- It will take extra time to make ice in the following cases.

- First time use (it may take 24 hours or more)
- When the Freezer Compartment temperature is set to "Cold"
- When a large amount of food is put into the refrigerator at once
- When the refrigerator is set to "Save"

- When the doors are opened and closed frequently
- When the Freezer Compartment or Ice Compartment doors are left partially open
- When the ambient temperature is low such as in winter
- When there is a power outage

Note

- When "On" or "Quick" is set, do not put anything other than ice made by the automatic ice maker in the ice storage space, such as frozen foods or the ice scoop. It will not be possible to make ice. It may prevent the ice from forming as parts of the ice maker may be obstructed by the food obstructing. Thus making it difficult to open the drawer and may cause damage to the parts.
- Open and close the door of the Ice Compartment slowly. If you open or close it vigorously, ice may spill from the ice case and fall into the Lower Freezer.

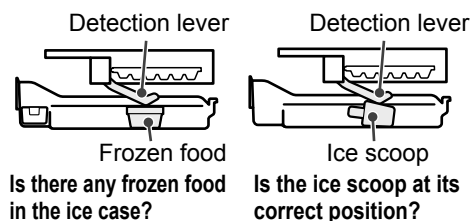

Quick Ice Making

Press **Ice Maker** to activate "Quick" indicator.

"Quick" finishes in about 7 hours, and the ice maker switches back to "On".

Note

- While "Quick Ice Making" is operating, cooling for the freezer compartment is given priority, so the temperature of the refrigerator compartment is likely to increase when the doors are opened and closed frequently.

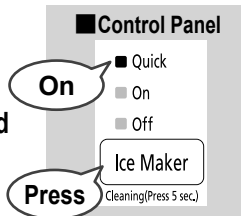

Stop Ice Making

Press **Ice Maker** to activate "Off" indicator.

※ If you want to stop ice making for one week or longer, please clean the automatic ice maker.

→ Pg.62, 63

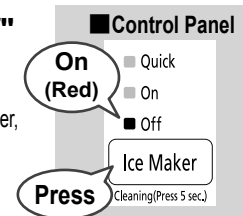

Water supply indicator

When the water level is low in the Water Supply Tank, the "Water" indicator lits. Add water to the Water Supply Tank.

When the left door of the refrigerator compartment is opened or closed, the "Water" indicator turns off once. It lights up again if water is not added. (Up to 3 hours later)

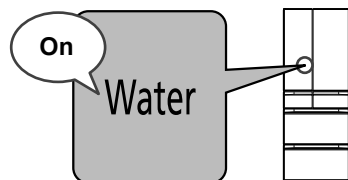

Note

- The "Water" indicator does not light when the automatic ice maker is "Off".
- If there is water in the Water Supply Tank but the Water Supply Tank is not pushed in firmly, the "Water" indicator will light up. Push in the Water Supply Tank so that it passes the "Container set position" line.
- Even when "On" is activated, the "Water" indicator may not light when the Ice Case is full.

Ice Maker "On" or Freezer "Coldest/Cold" and Fridge "Cold" are blinking

The ice tray may be in contact with food in the ice case.

Empty the ice case and perform "Ice Maker Cleaning".

→ Pg.63

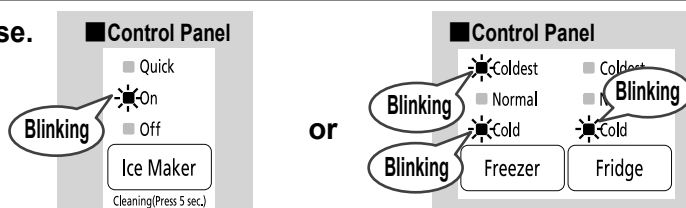

FREEZER COMPARTMENT

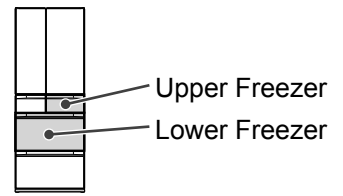

Upper Freezer

For storing foods for daily use or foods which has been partially used.

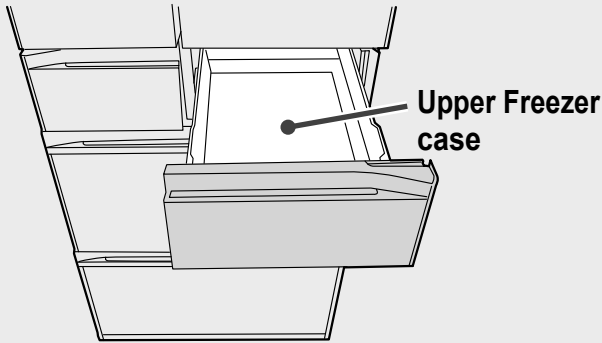

Lower Freezer

Large amount of foods can be stored in a 3-tier cases and can be organized neatly.

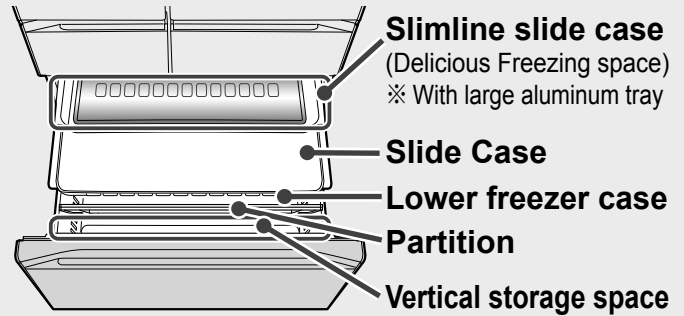

Caution ● The slimline slide case and the partition cannot be removed.

Storing food

Upper Freezer		Freezer bags, airtight containers, bread, etc.
Lower Freezer	Slimline slide case	Small frozen food items, etc. Delicious Freezing space To quickly freeze meat, fish and steamed rice
	Slide Case	Freezer bags, airtight containers, etc.
	Lower freezer case	Frozen food, ice cream, etc. Vertical storage space Plastic bottles designed to be used in freezers, etc

Food can be stored according to different type and sizes with the lower and upper freezer cases. Stored food should not touch the upper cases or partitions.

The doors may not close properly and the refrigerator may not cool properly. The food or the cases may also be damaged.

Caution

- Do not put plastic bottles in the slimline slide case. If the plastic bottle freezes, it will expand and will be impossible to take it out.
- Do not use the freezer with the Slide Case removed. Food may fall into the back of the case and the door may not close.
- Do not use containers not designed to be used in freezers.

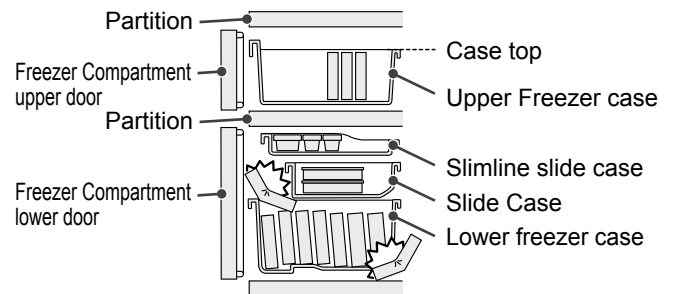

When freezing meat, fish, or rice (Using "Delicious Freezing")

Combined with the effect of the large aluminum tray, "Delicious Freezing" freezes food more quickly. Simply put the food in the Delicious Freezing space and the sensor will detect the temperature of the food and automatically switch the cooling operation.

Wrap the food in cellophane wrap or put it in a freezer bag and place it on the large aluminum tray. Cut food into small pieces so that it freezes faster and can be taken out easily too.

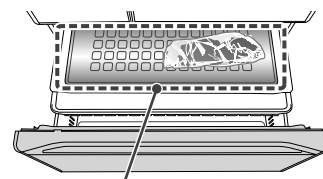

Delicious Freezing space

Note

- Freeze food more efficiently if placed in close contact with the aluminum tray and not stacked.

Adjusting the Temperature (Freezer)

You can change the temperature by pressing .

The default setting is "Normal". Select "Normal" for ordinary usage. Select "Coldest" if you need additional cooling, such as in the summer.

Note

If the refrigerator is too cold, set "Normal" or "Cold".

Note

- The temperature of the refrigerator will vary slightly depending on the operating conditions.
- You can also fine-tune the temperature. [→ Pg.58](#)
- Setting the freezer to "Coldest" consumes about 20% more power than the "Normal" setting.
- Changing the freezer temperature setting also changes the Ice Compartment temperature.

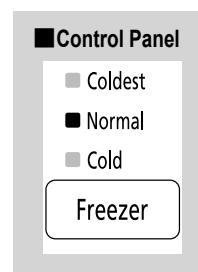

Guide for freezer temperature

"Coldest" is about 2 to 4°C lower than "Normal"

"Cold" is about 2 to 4°C higher than "Normal"

VEGETABLE COMPARTMENT

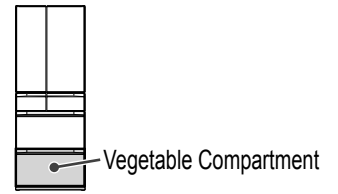

Vegetable Compartment

Platinum catalyst The platinum catalyst breaks down the odor component of food and ethylene gas from vegetables and converts it to carbon dioxide. This helps to keep food fresh. The platinum catalyst does not require replacement. Do not remove it.

Upper case

Lower case

Partition
※ Cannot be removed

Moisture unit
※ Do not remove.

Vertical storage space

Upper space

Vegetable Compartment door

Partition

Lower space (Aero-care Zone)

Storing food

Upper space	Partially used vegetables and small vegetables (tomatoes, bell peppers, etc.), fruits (strawberries, grapefruits, etc.)
Lower space	Leafy vegetables (spinach, Komatsuna (Brassica rapa), etc.), large vegetables (cabbage, lettuce, etc.)
Vertical storage space	Long vegetables (cucumbers, asparagus, etc.), 2 L plastic bottles, etc.

Store food according to its type and size.

● **Pay attention to the height of the food you store.**

- The doors may not close properly and the refrigerator may not cool properly. The food or the cases may also be damaged.
- Some food and bottles may not be possible to store within the compartment due to its size.

● **Do not use the Vegetable Compartment with the upper case removed.**

- Food may fall into the back of the case and the door may not close.

● **Do not force food or beverages into the Vegetable Compartment.**

- The partition or the cases may be damaged.

Guide to height

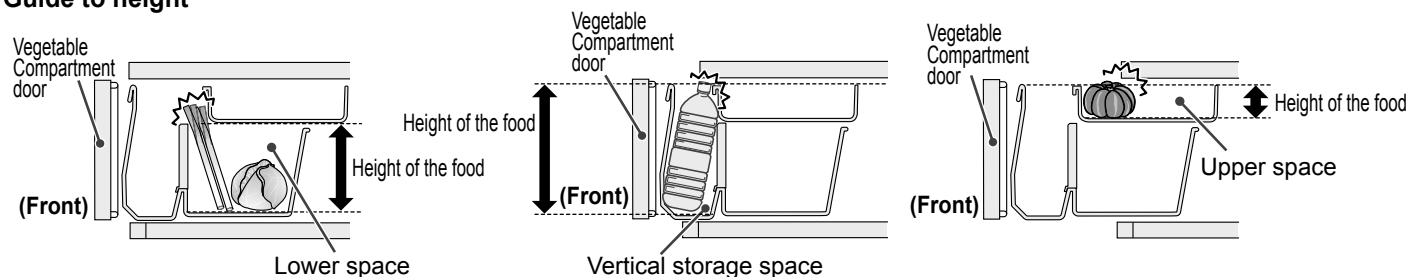

Adjusting the Temperature of the Vegetable Compartment (Using "Powerful" mode in 'Veg')

To set "Powerful" mode in 'Veg'

The default setting is "Off".

Press  to activate "Veg" indicator.

The refrigerator will cool at a lower temperature than usual.
(Normal temperature is about 4 to 8°C → "Veg" about 2 to 6°C)

※ The temperature assumes an ambient temperature of approx. 32°C around the refrigerator, the refrigerator and freezer compartments set to "Normal", without food inside, the doors closed, and a stable temperature.

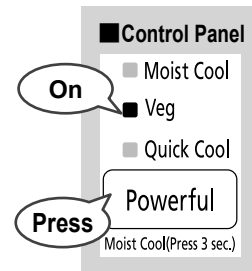

To cancel "Powerful" mode in 'Veg'

Press  to deactivate "Veg" indicator.

Note

- If you use "Veg" for a long period, vegetables with high water content may freeze. In this case, cancel the "Veg" setting.
- If "Save" mode is on while "Veg" is set, cooling is reduced starting from "Veg". → Pg.60
- When the outside temperature is low, the temperature inside the case may also be low.

In the following cases, cancel the "Veg" setting.

- If the surface of vegetables that are sensitive to low temperatures, such as eggplant, has dents or discoloration.
- If you are concerned about condensation in the Vegetable Compartment.

Tips for storing vegetables

■ Vegetables recommended for storage at room temperature

- It is recommended to store garlic, onions, potatoes, sweet potatoes and pumpkins (whole) in a cool dark place (where the room temperature is kept constant and low and away from direct sunlight).



■ Foods prone to low temperature damage

If you put food in the Vegetable Compartment for a long time, the color may change or the taste may deteriorate depending on the food. The food may lose vitamin C, become moldy, and rot.

- Vegetables...tomatoes, bell peppers, cucumbers, eggplants, green beans, sweet potatoes, okra, etc.

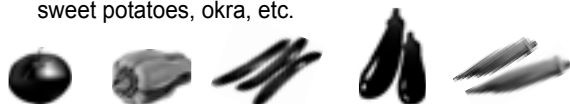

- Fruits...bananas, pineapples, mangoes, papayas, avocados, lemons, etc.



※ You can enjoy a delicious taste if you chill these fruits in the refrigerator for a short time before eating.

What to do in the following cases

- When you are storing a small quantity of vegetables, it may not be possible to maintain high humidity, so please wrap the vegetables in cellophane wrap.
- Due to the high humidity in the Vegetable Compartment, depending on the amount and type of vegetables, condensation may form on the case, the surface of the moisture unit, or the surface of food. If you are concerned about condensation, wrap the food in cellophane wrap.
- If the moisture unit is blocked by a food bag or container, a large amount of condensation will occur. Move the food bag or container blocking the moisture unit to another location.
- Food can easily get damaged if water collects in the case so wipe off the dew condensation with a soft cloth.
- When storing dry food such as rice or seaweed in the Vegetable Compartment, put it in a closed container (bag) before storing. Dried food may absorb moisture.

Note

The vertical storage space has a slightly higher temperature than other spaces.

VARIOUS FUNCTIONS

Further temperature adjustments (Refrigerator/Freezer)

The temperature settings of the Refrigerator Compartment and the Freezer Compartment can be further adjusted in 11 levels.

Control Panel

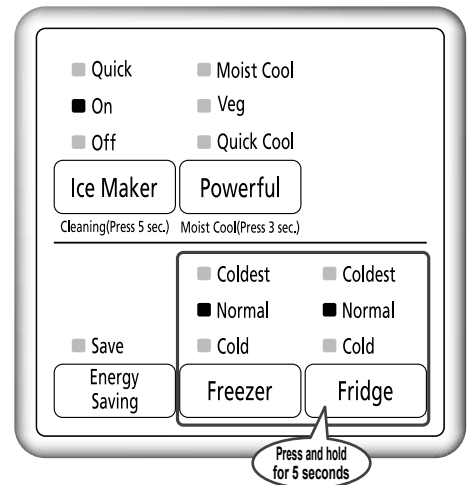

1

Open the Refrigerator Compartment door and Freezer Compartment lower door.

2

Press and hold **Fridge** for 5 seconds or longer until you hear a long beep.

3

Close the Freezer Compartment lower door.

4

Press **Fridge** or **Freezer** to adjust each compartment.

Each time you press it, the display changes in order as shown below. Select "Normal" for ordinary usage.

(●: lit, ■: blinking, ○: unlit)

	○ Coldest	○ Coldest	○ Coldest	○ Coldest	○ Coldest	○ Coldest	○ Coldest	○ Coldest	○ Coldest	○ Coldest	○ Coldest	○ Coldest
Display	○ Normal	○ Normal	○ Normal	○ Normal	○ Normal	○ Normal	○ Normal	○ Normal	○ Normal	○ Normal	○ Normal	○ Normal
	○ Cold	○ Cold	○ Cold	○ Cold	○ Cold	○ Cold	○ Cold	○ Cold	○ Cold	○ Cold	○ Cold	○ Cold
Settings	Lower	Low	→	→	→	Medium	→	→	→	High	Higher	

Release

Perform steps 1, 2, and 3.

There will be two short beeps, and normal adjustment (3 levels) will be restored.

"eco" operation indicator lamp

When the operation is relatively stable, **ECO** automatically lights up to indicate energy saving operation.

Use this indicator lamp as a reference for using the refrigerator wisely, such as by opening and closing the doors less often and putting and removing food quickly.

Note

If **ECO** does not light, it might be due to the following reasons:

- The refrigerator has just been installed or many foods have been stored at once
- The doors have been opened and closed frequently
- Food or a bag is stuck in a door so that it cannot close completely
- "Quick", "Quick Cool" or "Veg" is activated
- The temperature around the refrigerator is approx. 35°C or higher

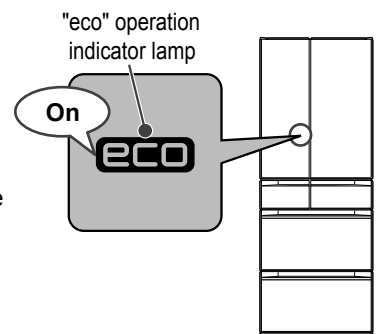

Door alarm

If you open one of the doors for 1 minute or more, there will be a beeping sound to indicate that the door is open. The door alarm function works with the Refrigerator Compartment, Ice Compartment and Lower Freezer Compartment. (It does not work with the Upper Freezer Compartment or the Vegetable Compartment)

Door opening time	After 30 seconds <small>(When "Energy Saving" mode is set)</small>	After 1 minute	After 2 minutes	After 3 minutes or more
Alarm sound	Beep (3 times)	Beep (3 times)	Beep (5 times)	Loud beep (continuous)
Indicator lamp on the Control Panel	—	—	—	Blinking

Note

Pressing the button has no effect when the operation panel lamp is blinking. Close the door then press the button again.

Volume adjustment of door alarm and operation sound

You can adjust the door alarm and operation sounds louder, or you can mute it.

The default setting is "Standard".

Press and hold Fridge for 3 seconds or longer until you hear a beep sound.

The operation sound volume can be switched to "Standard", "Loud", or "Off". Repeatedly change the setting to choose the volume level you prefer (see table below).

Volume	Standard	Loud	Off	Standard
Setting sound	—	Two long beeps	Long beep	Two short beeps
	(Default)			

Note

- It is not possible to adjust the door alarm and the operation sound to different volume levels.
- When the sound is turned off, the operation panel lamp will not blink while the door alarm is active.
- Even if the volume is set to "Off", the "Ice Maker Cleaning" alarm will sound. In addition, if you press and hold the button for 3 seconds or longer, a beep sound is heard after doing it. → Pg.63
- The setting returns to "Standard" after the power plug is disconnected and reconnected, or after operation restarts following a power outage.

Triple power deodorizing effect (Refrigerator)

Deodorizes various odors in the refrigerator including the four major odors of sulfur, nitrogen, aldehyde, and acid, by combining three types of deodorizing materials.

SAVING ENERGY

"Energy Saving" mode

Set the refrigerator to "Energy Saving" mode to save power by switching to weaker cooling for each compartment.

If the refrigerator door is left open for 30 seconds or more, the door alarm sounds and the LED interior light in the refrigerator dims to inform you to close the door quickly. If the doors are not opened for a long period of time, **the interior is cooled slowly to further reduce energy consumption.**

To activate "Energy Saving" mode

The default setting for "Energy Saving" mode is "Off" ("Save" indicator: Off).

Press  to activate "Save" indicator.

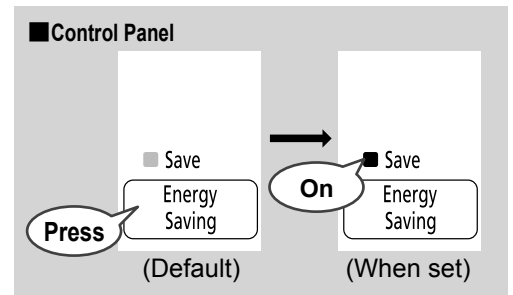

To cancel "Energy Saving" mode

Press  to deactivate "Save" indicator.

Note

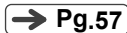
- Automatic temperature control lowers cooling loads, which may cause ice cream to become soft. It also requires more time for freezing and ice making.
- If "Quick" or "Quick Cool" is activated while "Save" is activated, weaker cooling operation is temporarily cancelled.
- If you have already set one or both of the "Freezer Compartment" and "Refrigerator Compartment" temperature to "Cold", cooling is not reduced further in order to ensure that food is kept fresh.
- If "Save" is activated while "Veg" is activated, cooling is reduced starting from "Veg". 

MAINTENANCE



WARNING

Please remove the power plug from the outlet before cleaning.

■ If there is dirt

Wipe it off immediately. It is also recommended to clean once a year.

Power plug

Once or twice a year

Unplug the power plug from the outlet and remove any dust with a dry cloth.

To prevent fire or electric shock → Pg.40



Door gasket

Once a month

To remove dirt, clean it with a soft damp cloth.

This area is easily dirty, please wipe the dirt off thoroughly.

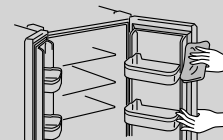

Door surfaces

Once a month

To remove stains, clean it with a soft damp cloth. Then wipe again with a dry cloth.

If there is tape glue on the glass surfaces, remove it by rubbing it with a plastic eraser and wiping it with a dry cloth.

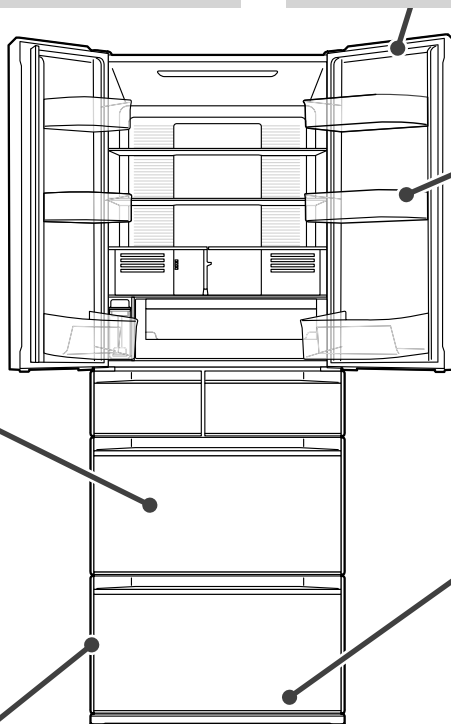
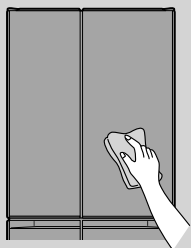

Shelves and Pockets

Once every 3 months

To remove dirt, clean it with a soft damp cloth

How to remove → Pg.64

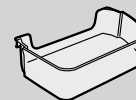

Liquid receiver

Once a month

To remove dirt, clean it with a soft damp cloth.

If liquid has collected or the liquid receiver has become dirty, wipe it off.

Liquid receiver

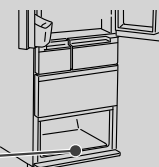

Refrigerator back/sides/bottom

Once or twice a year

Remove the leg cover, lift the adjustable mounts from the floor, pull the refrigerator toward you, and wipe off the dirt.

How to remove → Pg.44



Plastic parts (left and right)

- Fine dust tends to adhere to the back surface or the area around the plastic parts on the sides of the refrigerator at the bottom due to the convection of air and it becomes dirty easily. For floors that can easily be scratched, put down a protective board or similar.
- If you are concerned about vibration noise or the back wall becoming discolored or dirty due to moisture, install the refrigerator 2 cm or more away from the back wall.

Cases

Once every 3 months

To remove dirt, clean it with a soft damp cloth.

If you wash the Vegetable Compartment lower case with water, turn it over to drain the water, then wipe off the water thoroughly. Do not use long-bristle items such as a toothbrush or scrubbing brush. They may scratch the cases or break the moisture unit.

How to remove → Pg.65

※ Do not wash the platinum catalyst with water.

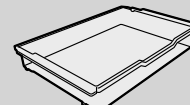

Note

- Do not use any of the following as they may damage or discolor the doors, painted surfaces, plastic, or glass surfaces.



Alkaline, weak alkaline kitchen detergents (other than neutral), glass cleaners, chlorine bleach

Scourer, polishing sponge, chemical cloth

Polishing powder, soap powder

Benzine, thinner, alcohol

Hot water

Check the "Liquidity" column of the "Labeling based on the Household Goods Quality Labeling Act" for detergents.

- If you spill edible oil, citrus juice, or food juice on any parts of the refrigerator, please wipe it off. The parts may become discolored or crack.
- Do not wipe the movable contact surfaces of the cases and slide door rails, as they are coated with lubricant. (The lubricant complies with the Food Sanitation Act)
- If you attach a magnet or suction cup to the side of the main body or to a door, it may leave a mark.
- When the power plug is unplugged, the settings on the Control Panel may be canceled. Set them again according to your preference.

MAINTENANCE (Continued)

Extra Fresh Room Once a month

1 Pull the Extra Fresh Case forward.

How to remove → Pg.64

Please remove the food stored in the Extra Fresh Case.

2 Wipe each part with a soft cloth moistened with warm water.

※ Do not use detergent, etc.

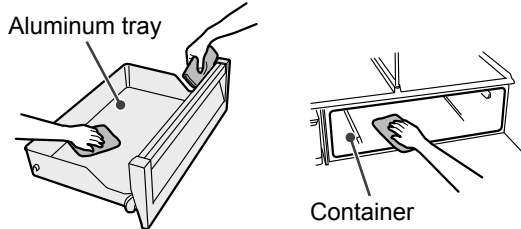

3 Attach the Extra Fresh Case.

How to attach → Pg.64

Water Supply Tank Once a week

1 Take out the Water Supply Tank and remove the lid.

- 1 Tilt the lid in the direction of the arrow.
- 2 Lift the front side of the lid.

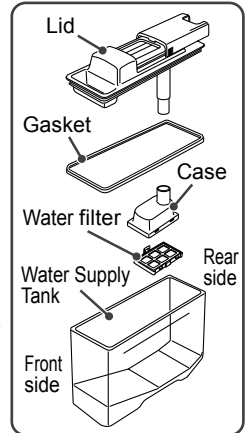
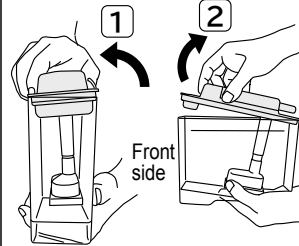

2 Remove the gasket and case from the lid.

Pull the case to remove it from the lid.

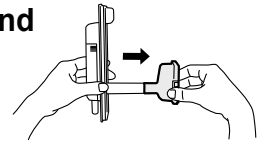

3 Remove the water filter from the case.

Pull the knob of the water filter to remove it from the fork, and remove the case.

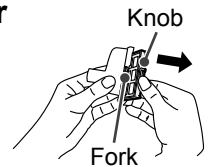

4 Wash each part of the Water Supply Tank with water.

Use a soft sponge.
Do not use detergent, etc.



Note

- The water filter should be replaced about every 3 to 4 years.

→ Pg.72

5 Attach each part of the Water Supply Tank, add water, and position it in place.

Insert the lid and case so that the protrusions are aligned.

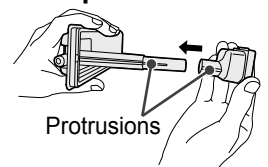

Insert the lid from the rear side and close it in the direction of the arrow.

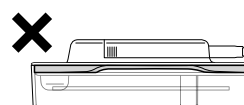
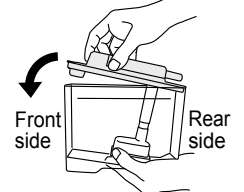
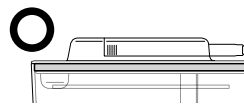

The gasket is twisted.

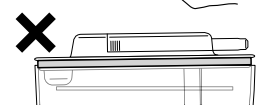

The lid is not closed properly and is lifted up.

Note

If you are not using the automatic ice maker for a long period of time, after cleaning the Water Supply Tank, dry it carefully and position it in place. (It is especially important to dry the water filter thoroughly.)

Ice maker cleaning

When using the automatic ice maker for the first time

When it has not been used for a week or longer



WARNING

Do not touch the mechanical part of the automatic ice maker.

(Doing so may cause injury.)

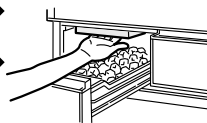

Rinse the ice tray and water channel.

Preparation

Before activating the "Ice Maker Cleaning", please check the following.

Water Supply Tank

- There is water up to the container full line.
- It is positioned correctly past the container set position.

Ice case

- If there is any ice in the ice case, remove it.



After checking the items on the left, close all the doors other than the Refrigerator Compartment door and do the following.

1 Press and hold **Ice Maker** for 5 seconds or longer until the alarm sounds.

The three indicators "Quick", "On", and "Off" blink at the same time, and "Ice Maker Cleaning" starts. (About 4 minutes)

- Close the Refrigerator Compartment door.
- The lamp blinks for about 4 minutes and the alarm continues to sound.
- You cannot cancel "Ice maker cleaning" partway through.
- If you open one of the refrigerator doors during "Ice maker cleaning", it may not work properly. Do not open or close any of the doors until "Ice maker cleaning" is finished.
- The alarm will be activated even if the door alarm is set to "Off". → Pg.59

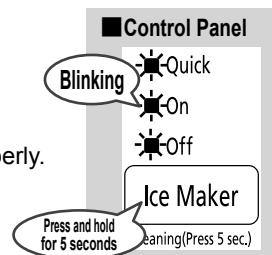

2 When the alarm stops, lay a clean towel on the bottom of the Ice Case to block the cutout at the rear.

Place a water-absorbing towel on the bottom of the Ice Case to prevent water collected during the ice maker cleaning process from spilling out of the cutout.

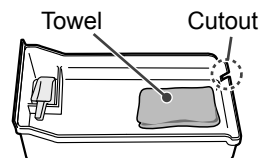

3 Remove the Ice Case, wipe off the water inside, and then place it into the Ice Compartment.

Remove the towel you used to wipe off water. You may continue to use the remaining water in the Water Supply Tank. After "Ice Maker Cleaning" is complete, the refrigerator resumes back to "On".

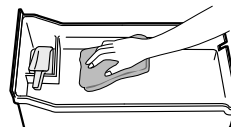

HOW TO REMOVE/ATTACH PARTS

Caution

- Before removing parts, remove any food inside.
- Do not remove parts except the ones listed here.
Please contact a Hitachi customer service center if you wish to remove and clean such parts. → Pg.76
- Do not remove the platinum catalysts in the Vegetable Compartment. Do not wash them with water.

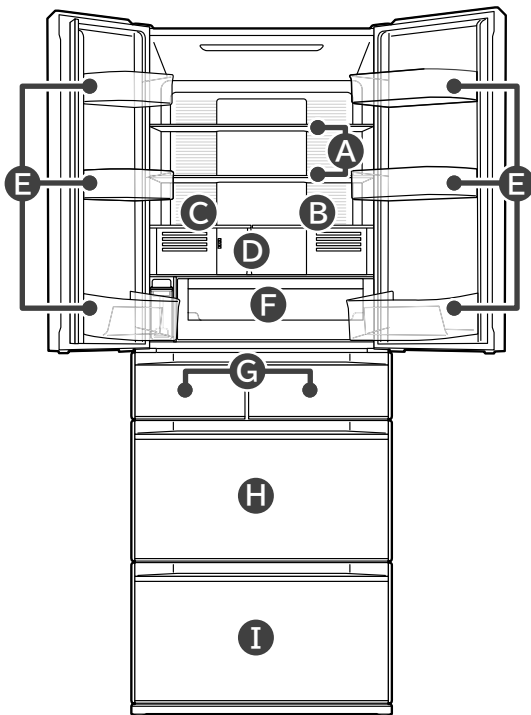

A Height adjustable upper and middle shelf

Request

To remove the shelves, remove the upper shelves first, then remove the lower shelves.

To attach the shelves, attach the lower shelves first.

- 1 Lift the back of the shelf a little and pull it toward you.
- 2 Raise the shelf as shown in the drawing.
- 3 Rotate and remove it.

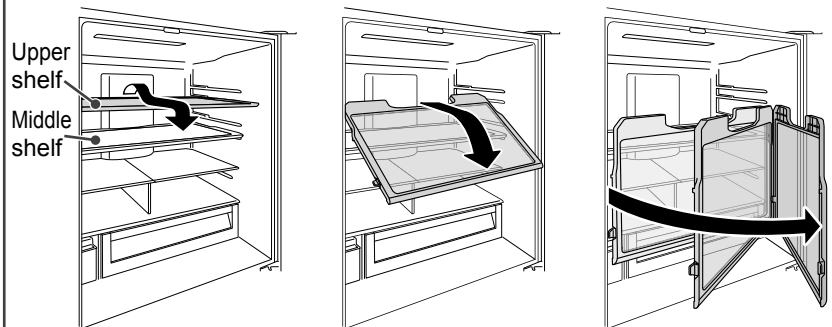

Caution

The glass shelves are heavy. Be careful when removing/attaching them. If a shelf falls, you may be injured or the shelf may break.

B Height adjustable lower shelf

Lift up the whole shelf a little and remove it.

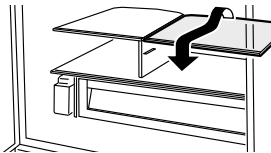

C Fixed shelf

While holding the shelf partition, lift the back of the shelf a little and pull it toward you.

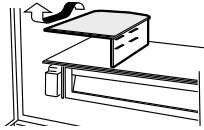

First remove the lower height adjustable shelf.

D Shelf partition

- 1 Hold the back and rotate it toward you.
- 2 Remove it while pushing it inward.

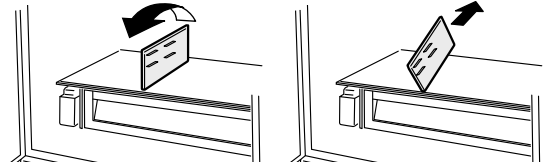

E Door pockets

Gently tap the left and right sides at the bottom and lift to remove. (The door pockets are fixed firmly)

Caution

When attaching, attach them firmly as far as possible. If they are not attached properly, they may come off and fall, resulting in injury.

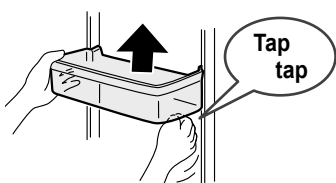

F Extra Fresh Case

To remove

Pull out the Extra Fresh Case, lift the front lightly and pull it diagonally upward.

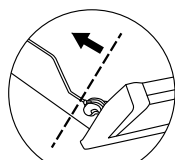

Caution

Hold the Extra Fresh Case from the dotted line. Failure to do so may cause your fingers to be pinched in the door.

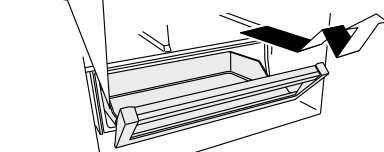

Caution

When removing the Extra Fresh Case, hold the entire case other than just the door or handle. Failure to do so may result in damage to parts.

To attach

Slide the left and right protrusions of the Extra Fresh Case under the guide rails of the container.

Note

Ensure that the Extra Fresh Case is correctly attached by moving it in and out several times after attachment.

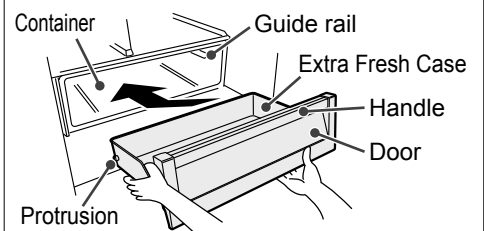

G Ice Case (Ice Compartment) and Upper Freezer case (Upper Freezer)

Open the door and lift the case toward you.

When attaching, place the bottom of the case on the frame to set it in place.

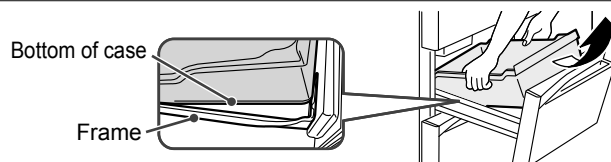

H Slide Case and Lower freezer case (Lower Freezer)

1 Open the door and pull out the slide case.

Caution ● The Slimline slide case cannot be removed.

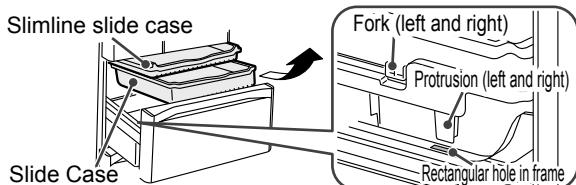

2 Lift the lower freezer case toward you.

Caution ● The partition cannot be removed.

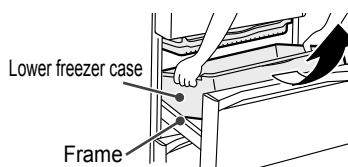

● Attach the slide case with the word "REAR" at the back side. If it is not set properly, there may be a strange noise when opening or closing the door, or it may cause the door to remain partially open.

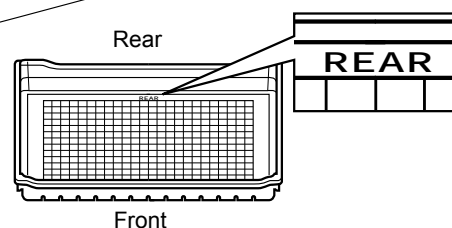

When attaching, insert the left and right protrusions of the lower freezer case into the rectangular holes of the frame and set it in place. Then, set the left and right forks of the slide case in place on the outside of the lower freezer case.

I Upper Case and Lower Case (Vegetable Compartment)

1 Open the door as far as possible. Lift both ends toward you, pull it out more slowly, and lower it to the floor.

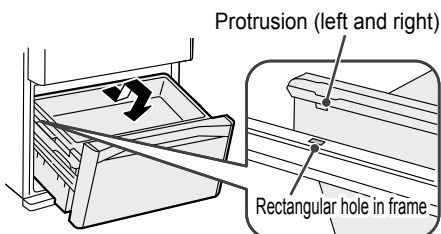

2 Pull up the upper case.

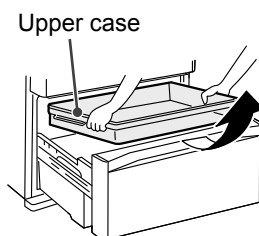

3 Lift the lower case forward.

Caution ● The partition cannot be removed.

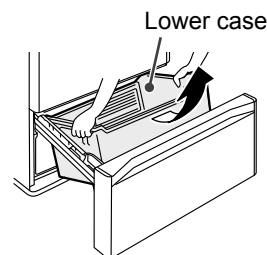

Caution ● Please keep your feet far enough away when opening the door. You may pinch your foot with the door.
● Note that water may drip from the back of the lower case.

If it is not set properly, there may be a strange noise when opening or closing the door, or it may cause the door to remain partially open.

Note ● If the upper case is not attached correctly, parts such as the case may break.
After attaching, slide the upper case back and forth to check that it is attached correctly.

How to remove/Attach the slide door (Ice Compartment/Upper Freezer/Lower Freezer/Vegetable Compartment)

Ice Compartment/Upper Freezer

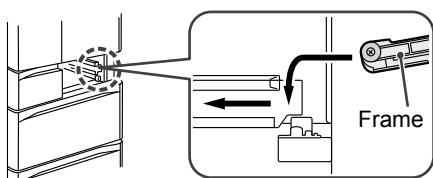

Lower Freezer/Vegetable Compartment

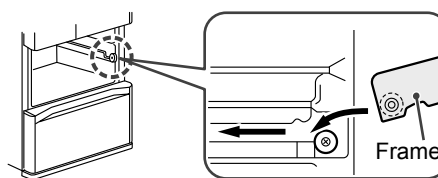

TROUBLESHOOTING

Check the following points before asking for repair.

Contact your dealer or our customer service centre if the problem still exists after checking. → Pg.76

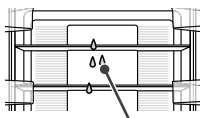
	Symptoms	Checks	Possible Cause
Initial stage	Not cold	Has 24 hours passed since the installation?	Cooling may take 24hours or more. Place food at interval time and refrain from opening and closing the door within 24hours. Cooling will take a longer time during summer or when large amount of food is stored.
	There is no ice	Have 24 hours passed since the installation?	As the entire refrigerator is not cooled immediately after installation, it takes more than 24 hours for the first ice to be made. Place food at appropriate intervals, refrain from opening and closing the doors as much as possible, and wait.
Refrigerator is not cold	Not cold enough Ice cream is soft.	Are there any food or package stuck inbetween the door preventing the door from closing completely?	Remove the food and close the door. Ensure the height of the food do not exceed the limit.
		Are the food squeezed together or is there a large amount of food store at one time?	Allow spaces inbetween the food in each compartment.
		Is the case in each compartment properly installed?	Install them properly. → Pg.65
		It may be difficult to cool depending on the location where the refrigerator is installed, the gaps, and the surrounding conditions.	Check if the refrigerator is installed properly. → Pg.44
		Is "Energy Saving" mode activated?	Deactivate "Energy Saving" mode. → Pg.60
		Is the temperature set to "Cold"?	Change the temperature setting of the compartment that is not cold. → Pg.48, 55
		Is the ambient temperature around the refrigerator too high, e.g. summer?	
		Have you left a door open for a long time or opened or closed it frequently?	The temperature inside the refrigerator gradually rises while one of the refrigerator doors is open. Frequently opening and closing the doors or leaving a door open for a long time makes it difficult for the temperature in the refrigerator to drop. Reduce the frequency of opening and closing of door, or open/close the door quickly.
Are the indicators on the control panel switching alternatively?	The refrigerator is in the demo mode. Please deactivate the mode. → Pg.68		
Frost or condensation formed	There is frost, condensation, or ice on the inside of the refrigerator or slide door frame.	Is the door or drawer close properly?	Check for any food or package stuck inbetween the door, and then close it completely.
		Have you left a door open for a long time or opened or closed it frequently?	When a door is opened or closed, water in the air may cling to the walls or parts in the Freezer in the form of frost or ice. Open and close the doors quickly, or reduce the frequency of opening and closing the doors. Wipe off any frost or condensation with a dry cloth.
	Condensation adheres to the outside of the refrigerator.	Is the air surrounding the refrigerator humid?	Condensation may adhere to these parts when the indoor humidity is high (e.g.: rainy day). Wipe off the condensation with a dry cloth.
		Is the temperature set to "Coldest"?	When the temperature is set to "Coldest", condensation may be formed on the surface of the doors. Set the temperature to "Normal". Wipe off the condensation with a dry cloth. → Pg.48, 55
	There is condensation on the back of the refrigerator and the walls.	Is the ambient of the refrigerator humid? Is there sufficient space between the back of the refrigerator and the wall?	Make sure there is at least 2 cm of space between the back of the refrigerator and the wall. → Pg.44
There is condensation inside the Refrigerator Compartment.	Have you left a door open for a long time or opened or closed it frequently?	Condensation may form on the walls and/or around the Cold Air Blowout Port when the doors are opened and closed frequently or when the humidity is high around the refrigerator. It does not indicate any fault. Wipe off the condensation with a dry cloth.  Condensation	

Symptoms	Checks	Possible Cause
Ice-maker is not working	Is "Off " lit on the control panel? If yes, the "Ice-making" mode has been turned off.	Activate it to "On" or "Quick" mode. → Pg.52, 53
	Is " Water " lit on the control panel? The water in the water supply tank is low.	Add water into the Water Supply Tank. → Pg.52, 53
	Is the water in the Water Supply Tank low?	If the water in the tank is low, ice may not be made. Add water until water level reaches the "Container full line" of the Water Supply Tank. → Pg.52
	Is the Water Supply Tank beyond the "Container set position" line?	Push it beyond the "Container set position" line. → Pg.52
	Is anything other than ice stored in the Ice Case?	Remove it from the Ice Case.
It takes a long time to make ice.	Is the Ice Case filled with ice over the limit line for stored ice?	Remove some ice. → Pg.53
	Are you opening the doors frequently or storing a large amount of food at once?	The inside is not cooled down enough. Minimize the opening and closing frequency of the doors until it is entirely cooled. Allow enough spacing between each item of stored food.
	Is the surrounding temperature low?	Ice making takes more than four hours during winter. Refrain from opening and closing the doors frequently and wait.
	Did you just changed the Ice Maker setting from "Off" to "On"?	Ice-making may take awhile to start after settings has been made. Refrain from opening and closing the doors frequently and wait.
	Are there any food or package stuck in between the door of the Freezer or Ice Compartments preventing the door from closing completely?	Remove the food and close the door.
	Is "Energy Saving" mode activated ?	Deactivate " Energy Saving " mode. → Pg.60
There are protrusions on the ice.	_____	This is caused by frozen water collected in the ice tray grooves. It is not a fault.
Stored ice becomes round. Ice cubes adhere together.	Is old ice left unused for a long time?	Old ice cubes naturally shrink and stick together. There is no problem as long as the ice cubes can be separated with the ice scoop.
	Are you opening the doors frequently or storing a large amount of food at once?	Reduce the frequency of opening and closing of door, or open/close the door quickly.
	Was one the Refrigerator Compartment doors or slide doors left partially open?	Close the door tightly.
The ice maker makes small ice cubes.	Is the water in the Water Supply Tank low?	When water is low, small ice cubes may be made. Add water until water level reaches the "Container full line" of the Water Supply Tank. → Pg.52
Freshly-made ice cubes adhere together.	_____	Water accumulated in the ice tray grooves may freeze and the ice cubes may adhere together. It does not indicate any fault.
There are white impurities in the ice cubes.	_____	This is due to the air bubble formed in the ice.
	Did you use mineral water to make ice?	The minerals contained in the water may freeze and turn white, but this is harmless.
If you are not making ice	_____	Activate "Off " mode. See "Stop Ice Making". → Pg.53

TROUBLESHOOTING (Continued)

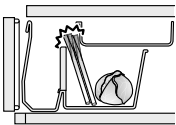
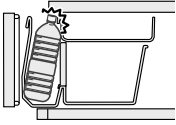
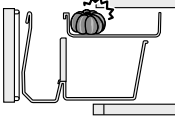
Symptoms	Checks	Possible Cause									
Indicator is blinking	3 or more indicators including "Save" lamp for energy saving and "Coldest/Normal/Cold" for freezer/fridge are blinking.	Please contact service centre for repair, indicate a making <input checked="" type="checkbox"/> at the blinking indicator. → Pg.76 <div style="border: 1px solid black; padding: 5px; margin-top: 10px;"> <p style="text-align: center;">(Checklist)</p> <table style="width: 100%; border-collapse: collapse;"> <tr> <td style="width: 33%;"><input type="checkbox"/> Save</td> <td style="width: 33%;"><input type="checkbox"/> Coldest</td> <td style="width: 33%;"><input type="checkbox"/> Coldest</td> </tr> <tr> <td><input type="checkbox"/> Energy Saving</td> <td><input type="checkbox"/> Normal</td> <td><input type="checkbox"/> Normal</td> </tr> <tr> <td><input type="checkbox"/> Freezer</td> <td><input type="checkbox"/> Cold</td> <td><input type="checkbox"/> Cold</td> </tr> </table> </div>	<input type="checkbox"/> Save	<input type="checkbox"/> Coldest	<input type="checkbox"/> Coldest	<input type="checkbox"/> Energy Saving	<input type="checkbox"/> Normal	<input type="checkbox"/> Normal	<input type="checkbox"/> Freezer	<input type="checkbox"/> Cold	<input type="checkbox"/> Cold
	<input type="checkbox"/> Save	<input type="checkbox"/> Coldest	<input type="checkbox"/> Coldest								
	<input type="checkbox"/> Energy Saving	<input type="checkbox"/> Normal	<input type="checkbox"/> Normal								
	<input type="checkbox"/> Freezer	<input type="checkbox"/> Cold	<input type="checkbox"/> Cold								
	Ice Maker "On" indicator blinking or "Coldest/Cold" and Fridge "Cold" indicator blinking	Food, etc. may be blocking the ice tray. Empty the Ice Compartment and activate "Ice Maker Cleaning". → Pg.63									
The Ice Maker "Quick", "On", and "Off" indicator blink simultaneously.	Did you place food or ice other than ice made by the automatic ice maker in the Ice Compartment?										
The Ice Maker "Quick", "On", and "Off" indicator blink simultaneously.	Did you press Ice Maker for 5 seconds or more?										
All the indicators are blinking.	Is the door opened? Is the door opened due to food stuck inbetween?										
Concerns on the Vegetable Compartment	The indicators are blinking continuously.	The refrigerator is in the demo mode. Please cancel the mode. In the demo mode, the refrigerator does not perform the cooling operation. Open the doors of the Refrigerator Compartment and the door of the Lower Freezer. After pressing any button to display the settings, press and hold the Freezer for 10 seconds or more until the preset sound is heard. All the indicator lamps are lit for a few seconds, the demo mode is cancelled and the cooling operation resumed. Close the doors of the Refrigerator Compartment (right and left) and the door of the Lower Freezer.									
	Condensation inside Vegetable Compartment.	Are there many vegetables with high water contents? Is the moisture unit blocked by packs of food or containers?									
	Unable to close the Vegetable Compartment Door / Upper Case of Vegetable Compartment is unable to slide back to original position.	Are there any food or package stuck inbetween the upper and lower case? 									
	Unable to close the Vegetable Compartment Door / Upper Case of Vegetable Compartment is unable to slide back to original position.	Is there any plastic bottle that is blocking the handle of the upper case? 									
	Unable to close the Vegetable Compartment Door / Upper Case of Vegetable Compartment is unable to slide back to original position.	Are there any food or package stuck inbetween the upper case and the top of the compartment? 									

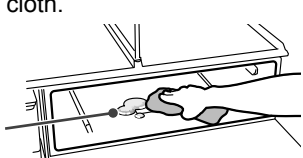
	Symptoms	Checks	Possible Cause
Concerns on the Extra Fresh Room or tilting of the doors	Water droplets, frost or ice is formed within the Extra Fresh Room.	Are you storing food with high water content?	<p>Moisture from food with high water content may cause condensation and/or frost to adhere inside the Extra Fresh Room because it is sealed.</p> <p>It is recommend to wrap foods with high water content in cellophane wrap. If there are water droplets or frost, wipe it off with a damp cloth.</p>  <p>Water droplets and frost</p>
	The doors of the refrigerator are uneven.	Is the floor even?	It will affect the quality of the refrigerator. If you are still concern, please adjust the left and right mounts. → Pg.44
Is the floor material soft and is the added weight of the stored items causing the legs to sink?		If the refrigerator body is tilting, install it on a sturdy board with a thickness of 1 cm or more.	
Strange smell	There is a plastic smell.	_____	This is because many plastic parts are used in the refrigerator, but the smell will decrease gradually as the refrigerator cools fully. It does not indicate any fault.
	The ice smells.	Is the Water Supply Tank or water filter dirty, or is the ice old?	Was the ice box regularly to prevent slime and water stains. → Pg.62, 63
		_____	There may be Chlorine smell from the tap water depending on the country you are staying.
It smells in the refrigerator.	Did you store any foods with strong smells without any wrappings?	The deodorizing function cannot completely remove all odors. Seal the such food with cellophane wrap.	
Refrigerator is too cold	The refrigerator is too cold. Food freezes.	Is the temperature set to "Coldest"?	Set the temperature setting to "Normal". → Pg.48, 55
		Is the ambient temperature 5°C or below?	When the ambient temperature is low, the inside of the refrigerator may become too cold. Set the temperature setting to "Cold".
		Is the food placed in front of the Cold Air Blowout Port?	Do not place food in front of the Cold Air Blowout Port. You can prevent food from freezing by using a lid or cellophane wrap.
Refrigerator becomes hot	The side of the refrigerator becomes hot. You feel a warm air current at your feet.	_____	The areas around the refrigerator can become hot as the heat generated by the cooling system is dissipated to the outside. Immediately after installation or in summer, the temperature may reach 50 to 60°C. Although there is no problem in terms of safety or performance, do not touch these areas.

TROUBLESHOOTING (Continued)

		Symptoms	Checks	Possible Cause
Concerns on noises	Abnormal sound from the refrigerator	Is the floor uneven?		Install the refrigerator on a sturdy board with a thickness of 1 cm. → Pg.44
		Is the refrigerator against the wall or furniture?		Install the refrigerator with space clearance around it.
		Is the refrigerator cold?		Operation sound may be loud as the compressor is operating at high-speed under the following conditions: Operating for the first time, frequent opening and closing of door, high surrounding temperature.
		Is "Quick" or "Quick Cool" activated?		When "Quick" or "Quick Cool" mode is activated, the compressor and fan motor operate at high speed, causing a high noise level.
	The operating sound goes on for a long time.		_____	Since the compressor is operated slowly to save energy, the operating noise may go on for a long time.
	Sometimes the sound gets louder.		_____	The driving force changes according to temperature changes in the refrigerator. As a result, you may feel that the refrigerator is noisy sometimes.
	Other abnormal sounds	Water trickling sound Water boiling sound Collision tapping sound Sizzling sound		This is the sound of the refrigerant flowing to cool the refrigerator, the sound of water flowing during defrosting, or the sound of evaporation. You may also hear noise from inside the refrigerator when you open one of the refrigerator doors. It does not indicate any fault.
		Squeaking, cracking and knocking sound		This is the sound of parts squeaking when the refrigerator temperature changes. It does not indicate any fault.
		Clacking sound Roaring sound Honking sound Banging sound		This is the sound of the electrical components that control the temperature inside the refrigerator. It does not indicate any fault.
		Sound of the automatic ice maker Motor noise Rattling noise Gurgling noise		This is the sound when ice leaves the automatic ice maker's ice tray or when water is poured into the ice tray. It does not indicate any fault. If you do not want to make ice, press  and set the mode to "Off." → Pg.53
Occasional sounds (rattling) (grinding)			This is the sound of starting or ending the cooling of the refrigerator. It does not indicate any fault.	

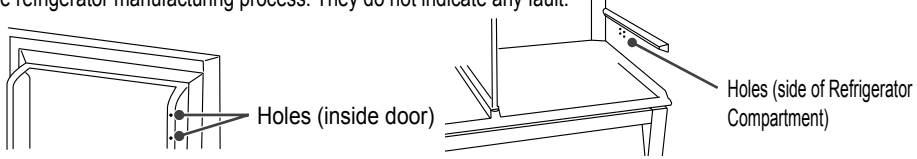
Symptoms		Possible Cause	
Others	Electric shock when you touch the body of the refrigerator	The refrigerator may be charged with static electricity. This is safe.	
	Static interference on radio and television	This is due to the very slight electromagnetic waves generated by this refrigerator. Install the refrigerator away from TVs, radios, entry phones, etc. Keep the power supply line away from any antenna wires.	
	There are thin hair lines on the plastic parts.	These lines are caused by liquid resin flowing when the plastic is molded. Especially visible on transparent parts. There is no issue with the quality and will not crack.	
	The door surfaces/the sides or top surface of the refrigerator are wavy or distorted.	Slight waving and/or distortions are generated in the manufacturing process of the refrigerator. They may be conspicuous depending on the position and brightness of the light source, but they are not a fault. Also, they do not affect the performance of the refrigerator.	
	There are small holes inside the door and on the side of the Refrigerator Compartment.	<p>These holes are used to release the internal air when filling the doors and compartment with insulating material in the refrigerator manufacturing process. They do not indicate any fault.</p>  <p>※ Depending on the product, stickers may be affixed. Do not remove these stickers.</p>	
	There was a power outage.	Reduce the frequency of opening and closing the doors and avoid storing additional food until the power supply is restored. After the power is restored, check the settings on the Control Panel.	
	If you are not using the refrigerator for a long time.	Remove all the items in the refrigerator. Remove the power plug and clean the inside of the refrigerator and automatic ice maker. → Pg.61-63 Leave all the doors open for 2 or 3 days to dry the refrigerator.	
	Removing frost.	This refrigerator automatically defrosts, so no action is required. The thawed water will be collected in the evaporation tray and automatically evaporates.	
	Moving/transporting the refrigerator	See "Preparation for moving/transporting (moving house) ". → Pg.72	
	Broken glass (door glass/glass shelf)	Do not touch the broken glass, and immediately contact your dealer for repair.	
	When I close one door, another door opens.	Did you close the door with too much force? Since each compartment is connected by a cold air passage, other doors may open momentarily due to the change in air pressure when the door is closed.	
	The door becomes heavy after I tried to open it again immediately after closing.	Did you leave the door open for a long time? This is because the air that has entered the refrigerator is suddenly cooled and the pressure temporarily drops. Rather than leaving the door open for a long time, open and close it each time you need to take something out or put something in.	
	If you are concerned about vibration noise or the back wall becoming discolored or dirty due to moisture	Install the refrigerator 2 cm or more away from the back wall. → Pg.44	
	A fly or other insect enters the refrigerator.	Are there flies near the refrigerator?	Keep the environment clean. Use an insect trapper.
Does the refrigerator contain food with strong odors?		Cover or wrap the food.	
Has the door been left opened for a long time?		Close the refrigerator doors as quickly as possible after taking the food from the refrigerator.	

TROUBLESHOOTING (Continued)

Preparation for moving/transporting (moving house)

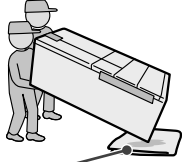
- | | | | | |
|----------|--------------------------------------------------------------------------------------------------------------------------------------------------------------------------------|----------|--------------------------------------------------------------------------------------------------------------------------------------------------------------------------------------------------------|--------------------------------------------------------------------------------------------------------|
| 1 | Remove all the food and ice. | 7 | Place a cloth under the refrigerator, tilt the refrigerator backwards, and drain water from the bottom at the back. |  <p>Cloth, etc.</p> |
| 2 | Pour away the water in the Water Supply Tank and ice tray.
Remove the Water Supply Tank and perform "Ice Maker Cleaning". → Pg.63 | 8 | Hold the carrying handle and carry the refrigerator with two or more people.

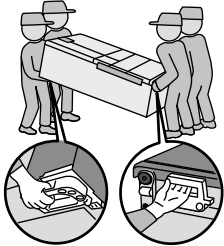
Do not stack the refrigerator horizontally when shipping it. (It may cause the refrigerator to malfunction) |  |
| 3 | Unplug the power plug.
This can be done just before moving the refrigerator. | 9 | Install according to " Before use". → Pg.44, 45 | |
| 4 | Remove the leg cover and raise the adjustable mounts. → Pg.44 | | | |
| 5 | Secure the door and power cord with tape. | | | |
| 6 | Lay protective sheets or fabric when moving or transporting the refrigerator.
This is to prevent damage to the flooring and spillage of water. | | | |

AVAILABLE PARTS

■ During the purchase of the following parts, please specify your refrigerator model. Only purchase parts from authorised dealers.

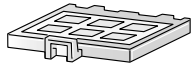
When this happens	Product name	Model	Product model	
The ice smells. The water filter may be old and dirty. (The usage period is approximately 3 to 4 years)	Water filter for the automatic ice maker	Common to all models	RJK-30	

—MEMO—

Handwriting practice area with 20 horizontal dashed lines.



有關碳氫化合物的雪櫃／可容納的食品重量

NOTES ON NON-CFC REFRIGERATORS/GUIDE ON TOTAL STORABLE WEIGHT



有關碳氫化合物的雪櫃 Notes on non-CFC refrigerators

- 本雪櫃所使用雪種及其他斷熱材料皆無使用氟氯化碳，而是使用碳氫化合物。碳氫化合物不會破壞地球臭氧層，對地球溫室效應的影響非常小，屬於環保物質。
- 碳氫化合物為可燃型物質。雪種密封於雪種迴路管中，在一般的使用情況下應該不會發生外洩。但萬一有雪種管線損壞的情況發生，請遠離火源及避免使用電器用品，將門窗打開以利空氣流通。之後，請立即與經銷商或日立技術中心聯絡。
- This refrigerator uses hydrocarbons, instead of chlorofluorocarbons (CFCs), in its refrigerant and insulation materials. Hydrocarbons do not damage the ozone layer, have minimal impact on global warming, and are thus considered comparatively environment-friendly.
- Note that hydrocarbons are flammable. The refrigerant is sealed in the cooling circuit and should not leak under normal operation. If the cooling circuit is damaged, open a window to ventilate the room, and avoid using fire and electrical appliances. Keep your distance from the refrigerator, and contact a customer service center to request repair.

可容納的食品重量 Guide on total storable weight

可容納於層架或收納盒內的食物重量如下：

Refer to the following table as a guide on the total weight of food that can be stored on each shelf or in each container.

	零件名稱 Name of parts	R-HV490R 型號 R-HV490R Type
冷藏室 Refrigerator compartment	可調式層架上段 Height adjustable upper shelf	16.5kg
	可調式層架中段 Height adjustable middle shelf	16.5kg
	可調式層架下段，固定層架 Height adjustable lower shelf, Fixed shelf	17.5kg
	-1°C特鮮冰溫室上方的層架 Shelf above the Extra Fresh Room	9.5kg
	-1°C特鮮冰溫箱 Extra Fresh Case	3.5kg
	容器置物架 (右側) 合計 Total for the right door pockets	16.0kg
	容器置物架 (左側) 合計 Total for the left door pockets	12.5kg
製冰室 Ice compartment	製冰格  17頁	
	Ice Case  Pg.53	
上層冰凍室 Upper freezer compartment	上層冰凍格 Upper Freezer case	5.0kg
下層冰凍室 Lower freezer compartment	上層滑動格 Slimline slide case	4.0kg
	中層滑動格 Slide case	5.0kg
	下層冰凍格 Lower freezer case	13.0kg
蔬果保鮮室 Vegetable compartment	上層滑動格 Upper Case	4.5kg
	下層置物格 Lower Case	15.0kg

關於廢棄之重要警告 Important notes on disposal

隔熱材料中含有環戊烷 (Cyclopentane)。

當要處理隔熱材料中之氣體時，必須依照特殊的廢棄處理程序。

要廢棄本產品時，為了不會對環境造成不良影響，請詢問當地的相關機關。

The insulation material of this refrigerator uses cyclopentane and other gases that require special procedures for safe disposal. To dispose of this refrigerator, please contact your local environmental protection agency (or some other relevant agency), and inquire about safe disposal procedures.

關於售後服務 AFTER-SALES SERVICE

電源線受損或需要維修時，請直接洽詢下列日立服務中心。

使用中出現異常現象時，請立即拔掉電源插頭以及聯絡售後服務中心以進行修理。

Please contact one of the following Hitachi customer service centers if the power cord is damaged or maintenance is required.

If the refrigerator malfunctions, immediately unplug the power cord, and contact a customer service center to request repair.

- Hong Kong
Arcelik Hitachi Home Appliances Sales Hong Kong Limited
18/F., Ever Gain Centre, 28 On Muk Street, Shatin,
N.T., Hong Kong, China
Tel: +852-2753-5386
Fax: +852-2753-0993
- Singapore
Arcelik Hitachi Home Appliances Sales (Singapore) Pte. Ltd.
438A Alexandra Road, #01-01/02/03, Alexandra
Technopark, Singapore 119967
Tel: +65-6536-2520
Fax: +65-6536-2521
- 香港
阿奇立克日立家電(香港)有限公司
中國 香港 新界 沙田 安睦街 28 號 永得利中心 18 樓
Tel: +852-2753-5386
Fax: +852-2753-0993

